

LM5118 Evaluation Board

National Semiconductor
Application Note 1819
Ron Crews
April 30, 2008



Introduction

The LM5118 evaluation board is designed to provide the design engineer with a fully functional, Emulated Current Mode Control, buck-boost power converter to evaluate the LM5118 controller IC. The evaluation board provides a 12V output with 3A of output current capability. The evaluation board's wide input voltage range is from 75V to 5V, with operation down to 3V with some component changes. The evaluation board operates at 300 kHz, a good compromise between conversion efficiency, tradeoffs between buck and buck-boost mode requirements, and converter size. The printed circuit board consists of 4 layers with 2 ounce copper top and bottom, and 1 ounce copper on internal layers. The board is constructed with FR4 material. This application note contains the evaluation board schematic, Bill-of-Materials (BOM) and a quick setup procedure. Refer to the LM5118 data sheet and quick start for more complete circuit and design information.

IC Features

- Integrated high and low side driver
- Internal high voltage bias regulator
- Ultra-wide input voltage range: 5V to 75V
- Emulated current mode control
- Single inductor architecture
- VOUT operation below and above VIN
- Single resistor sets oscillator frequency
- Oscillator synchronization capability
- Programmable soft-start
- Ultra low (<10 μ A) shutdown current
- Enable input
- Wide bandwidth error amplifier
- Adjustable output voltage 1.23V-75V
- 1.5% feedback reference accuracy
- Thermal Shutdown
- No VIN to VOUT connection during fault protection

Package

TSSOP-20EP (Exposed Pad)

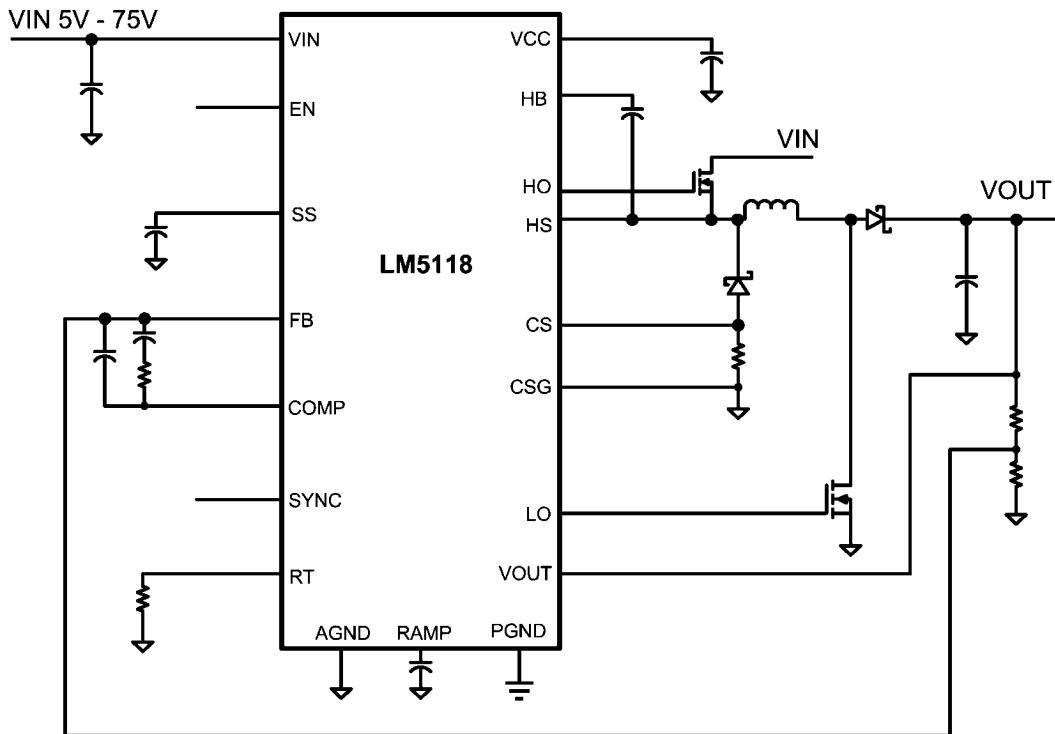

30057501

FIGURE 1.

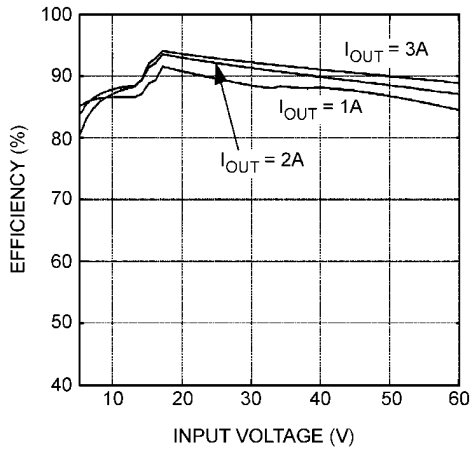

30057502

FIGURE 2. Efficiency

Figure 2 illustrates the efficiency of the converter vs. input voltage and output current. These curves highlight the high efficiency of the converter, especially considering the simplicity of design offered by a non synchronous implementation. Note the discontinuity in the curves at approximately 17V and 13V which represent mode transition boundaries. The lower efficiencies in the buck-boost region reflect additional losses at higher input and inductor currents. The decrease in efficiency at higher input voltages represents higher switching losses.

The performance of the evaluation board is as follows:

Input Range: 75V to less than 5V at full current

Operation to 3V at reduced current and appropriate adjustments*

Output Voltage: 12V

Output Current: 0 to 3A

Frequency of Operation: 300 kHz

Board Size: 3.45 X 2.65 inches

Load Regulation: 1%

Line Regulation: .1%

Over-Current Limiting

Operation with VIN greater or less than Vout

*Operation at full current to around 3V is possible with current limit sense resistor, UVLO threshold, and corresponding C_{ramp} adjustment. Additional input capacitance may be required. See the datasheet and quick start for more details.

Air Flow

Prolonged operation without airflow at low input voltage and at full power will cause the MOSFET's and Diodes to over-heat. A fan with a minimum of 200 LFM should always be provided. Figure 3 illustrates the temperature rise of various components with no airflow. The ambient was 25°C, and VIN was 8V.

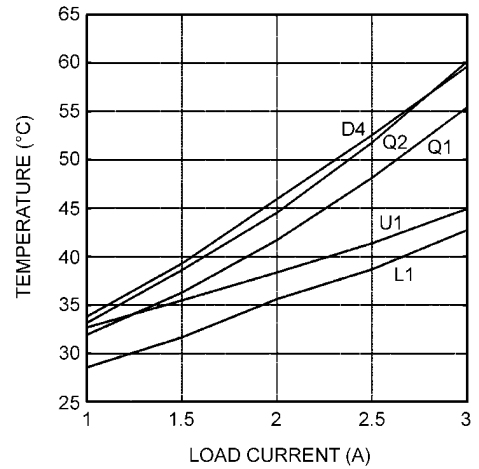

30057503

FIGURE 3. Temperature vs Load Current with No Airflow – 25°C Ambient

Powering Up

Connecting the IC's enable pin to ground will allow powering up the source supply with a minimal output load. Set the current limit of the source supply to provide about 1.5 times the anticipated wattage of the load. Note that input currents become very high at low input voltages, which requires an appropriate input supply. As you remove the connection from the enable pin to ground, immediately check for 12 volts at the output.

A quick efficiency check is the best way to confirm that everything is operating properly. If something is amiss, you can be reasonable sure that it will affect the efficiency adversely. Few parameters can be incorrect in a switching power supply without creating losses and potentially damaging heat.

Over Current Protection

The evaluation board is configured with over-current protection. The output current is limited to approximately 4.5 amps in the buck-boost mode. The 4.5A value allows for component tolerances to guarantee a 3A output current. Note this current will be almost double, or about 7 amps in buck mode (VIN greater than 17 volts) due to the difference in peak inductor currents in the two different modes. However, a hard short will trigger the hiccup mode of current limit as illustrated in Figure 4. In this mode, the average output current will be less than 2 amps.

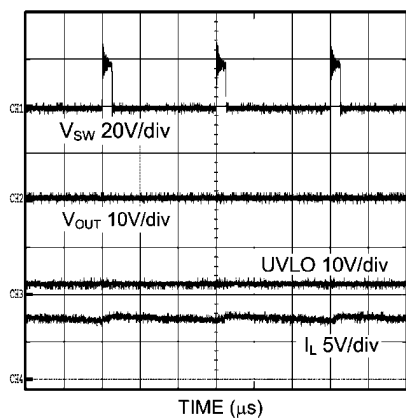

30057504

FIGURE 4. Short Circuit Current

VCCX

A place for a jumper between VOUT and VCCX is provided on the PC board. If operation below about 6 volts is required, connect the jumper to allow VCCX to power the converter (the exact voltage depends on the gate drive requirements of the switching FETs). The converter does require a minimum VIN of 5V to initially start. When running, the input voltage can decrease to below 5V at reduced current with VCCX connected to VOUT. Note that this design uses a current limit value to guarantee a full 3A of output current at a minimum VIN of 5V. For operation lower than 5V, the current limit resistor, UVLO threshold, and ramp capacitor must be re-calculated. Caution: make sure the input supply can source the required input current. Operation at low VIN at full power may overheat and damage the MOSFET's and Diodes supplied on the board. Note there is a limit of 14 volts applied to VCCX. Never exceed this value if operating VCCX from an external source, or operating the board with Vout greater than 12 volts. To prevent oscillation, connect an additional 100uF or

greater electrolytic capacitor across Vin for input voltages less than 5 volts.

Mode Transition

With Vout set at 12 volts, the LM5118 applications board will operate in the buck mode with VIN greater than about 17 volts. As VIN is reduced below 17 volts, the converter begins to operate in a soft buck-boost mode. As VIN is decreased below 14 volts, the converter smoothly transitions to a pure buck-boost mode. This method of mode transition insures a smooth, glitch free operation as VIN is varied over the transition region.

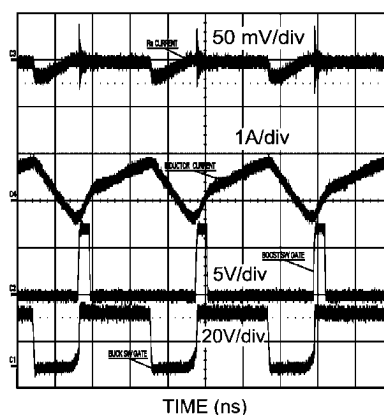

30057505

FIGURE 5. Mode Transition

Figure 5 illustrates soft mode transition. The boost switch pulse-width is relatively narrow compared to the buck switch waveform. The boost switch pulse-width will gradually increase as VIN decreases, and will eventually match and lock to the buck switch waveform. At this point, the converter enters full buck-boost operation.

Typical Waveforms

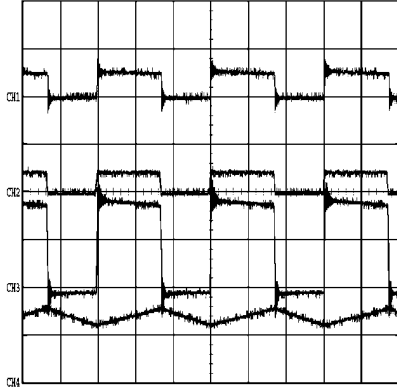

30057506

CH1: $V_{SW} = 20V/div$
 CH2: $Q1 = 20V/div$
 CH3: $Q2 = 10V/div$
 CH4: $I_L = 5A/div$

FIGURE 6. $V_{in} = 10V$, $I_{out} = 1A$, illustrating Buck-Boost Operation

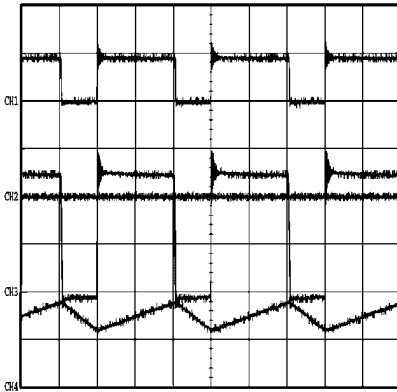

30057507

CH1: $V_{SW} = 20V/div$
 CH2: $Q1 = 20V/div$
 CH3: $Q2 = 10V/div$
 CH4: $I_L = 2A/div$

FIGURE 7. $V_{in} = 18V$, $I_{out} = 3A$ Illustrating Buck Operation

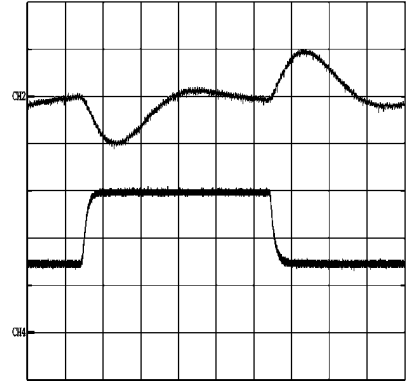

30057508

CH2: $V_{OUT} = 0.1V/div$
 CH4: $I_{OUT} = 1A/div$

FIGURE 8. Transient Response

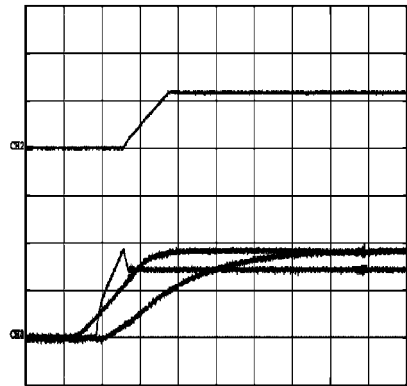

30057509

CH1: $V_{IN} = 10V/div$
 CH2: $V_{OUT} = 10V/div$
 CH3: $V_{CC} = 5V/div$
 CH4: $UVLO = 5V/div$

FIGURE 9. Start-Up Waveforms

Evaluation Board

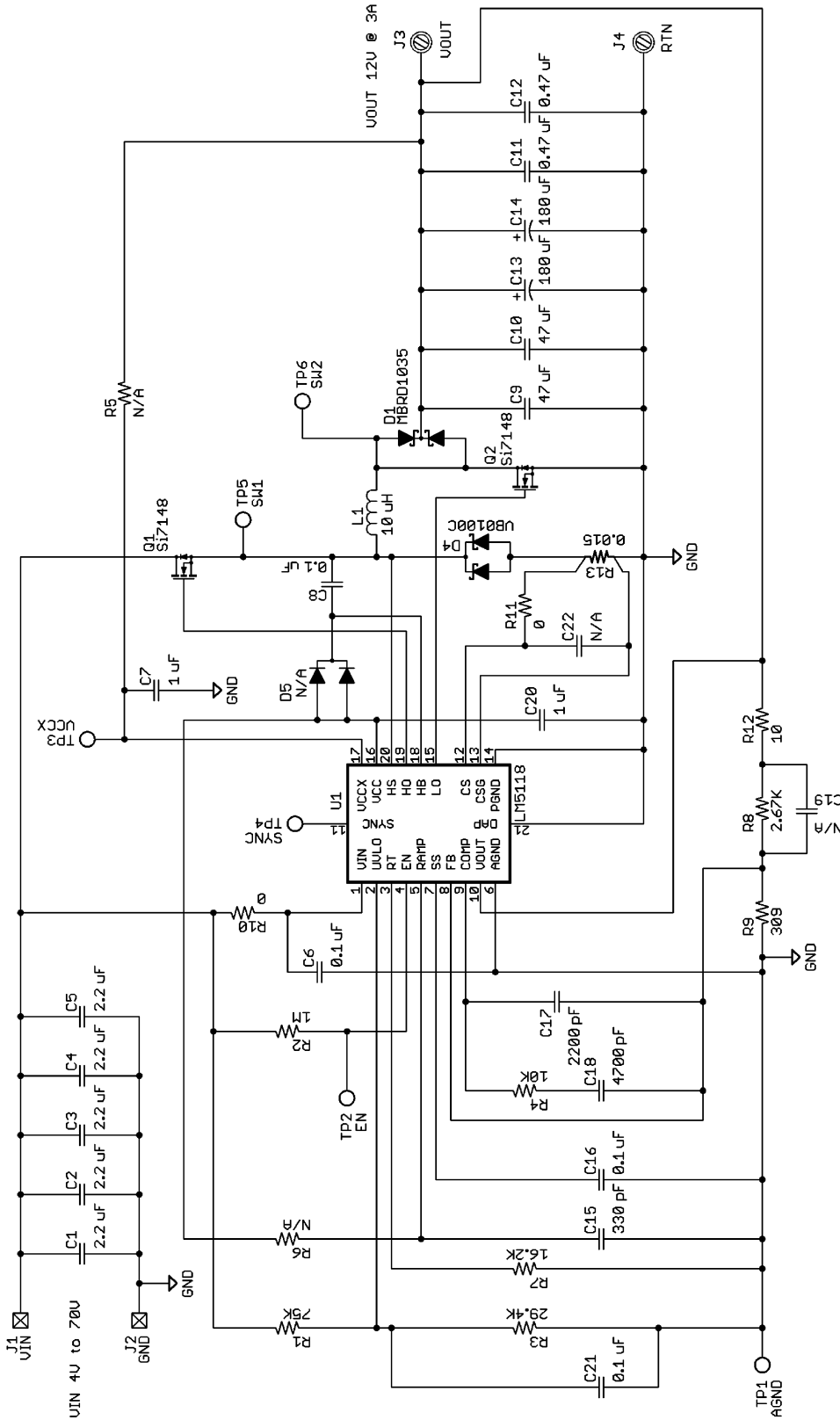

30057510

FIGURE 10. Evaluation Board Schematic

TABLE 1. Bill of Materials

Qty	Reference	Value	Device	Part Number	Manufacturer
2	C1, C2	2.2 μ F, 100V, X7R	SMD 1812	C4532X7R2A225KT	
3	C3, C4, C5	2.2 μ F, 100V, X7R	SMD 1812	C4532X7R2A225KT	TDK
2	C6, C8	0.1 μ F, 100V, X7R	SMD 0805	GCM21BR72A104KA37L	MURATA
2	C7, C20	1 μ f, 25V, X7R	SMD 0805	GCM21BR71E105KA56L	MURATA
2	C9, C10	47 μ F, 16V, X5R	SMD 1210	ECJ-4YB1C476M	PANASONIC
2	C11, C12	0.47 μ F, 25V, X7R	SMD 0805	GRM21BR71E474KC01L	MURATA
2	C13, C14	180 μ F, 16V	CAP, ELECTR POLY, SMD	PXA160ARA181MJ80G	NIPPON CHEMICON
1	C15	330 pF, 100V, COG	CAP_SMDC0603	GRM1885C2A331JA01D	MURATA
1	C16	0.1 μ F, 100V, X7R	CAP_SMDC0603	GCM188R72A104KA37D	MURATA
1	C17	2200 pf, 100V, COG	CAP_SMDC0603	GRM1885C1H222JA01D	MURATA
1	C18	4700 pF	CAP_SMDC0603	C1608X7R2A472M	TDK
2	C19, C22	N/A	CAP_SMDC0603		
1	C21	0.1 μ F	CAP_SMDC0603	GRM188R72A104KA35D	MURATA
1	D1	SCHOTTKY 10A 35V	DPAK TO-252	MBRD1035CTLT4G	ON-SEMI
1	D4	SCHOTTKY 40A 100V	D2PAK TO-263AB	VB40100C-E3/4W	VISHAY
1	D5	N/A	SOT-23		
1	J1, J2	INPUT	TERMINAL_TURRET	1503-2	KEYSTONE
1	J3, J4	OUTPUT	TERMINAL15A	7693	KEYSTONE
1	L1	10 μ H	IND_SER2800	SER2814H-103	COILCRAFT
1	L1A	N/A			
2	Q1, Q2	NFET	PPAK_SO8	SI7148DP-T1-E3	VISHAY
1	R1	75.0K, 1%	SMD 0603	ERJ-3EKF7502V	PANASONIC
1	R2	1M, 1%	SMD 0603	ERJ-S03F1004V	PANASONIC
1	R3	29.4K, 1%	SMD 0603	ERJ-3EKF2942V	PANASONIC
1	R4	10K, 1%	SMD 0603	ERJ-3EKF1002V	PANASONIC
1	R5	N/A	SMD 0603		
1	R6	OMIT			
1	R7	16.2K, 1%	SMD 0603	ERJ-3EKF1622V	PANASONIC
1	R8	2.67K, 1%	SMD 0603	ERJ-3EKF2671V	PANASONIC
1	R9	309, 1%	SMD 0603	ERJ-3EKF3090V	PANASONIC
1	R10	0 Ω , 1%	SMD 1206	ERJ-8GEY0R00V	PANASONIC
1	R11	0 Ω , 1%	SMD 0603	ERJ-3GEY0R00V	PANASONIC
1	R12	10 Ω , 1%	SMD 0603	ERJ-3EKF10R0V	PANASONIC
1	R13	0.015 Ω , 2W, 2%	SMD 7520	RL7520WT-R015-F	SUSUMU
1	TP1, TP2, TP3, TP4, TP5, TP6	TEST	TEST_POINT2	5012	KEYSTONE
1	U1	IC, PWM	TSSOP 20	LM5118MH	NATIONAL SEMICONDUCTOR

Schematic and Layout

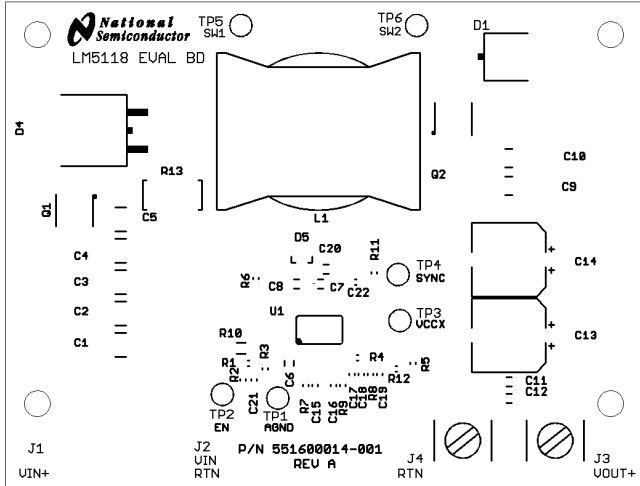

Top Silkscreen Layer as Viewed from Top

30057511

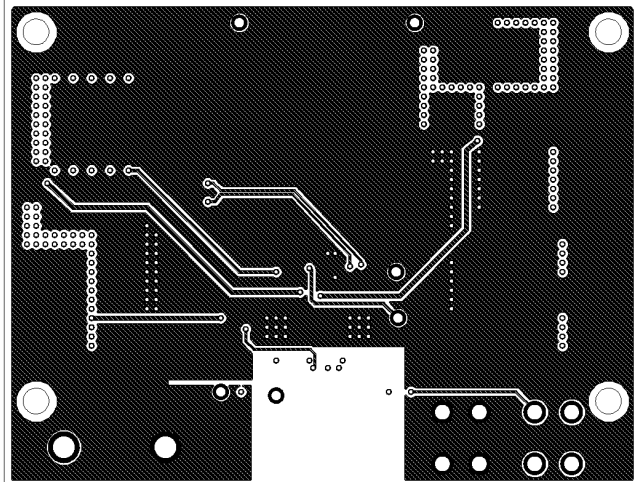

Layer 3 as Viewed from Top

30057514

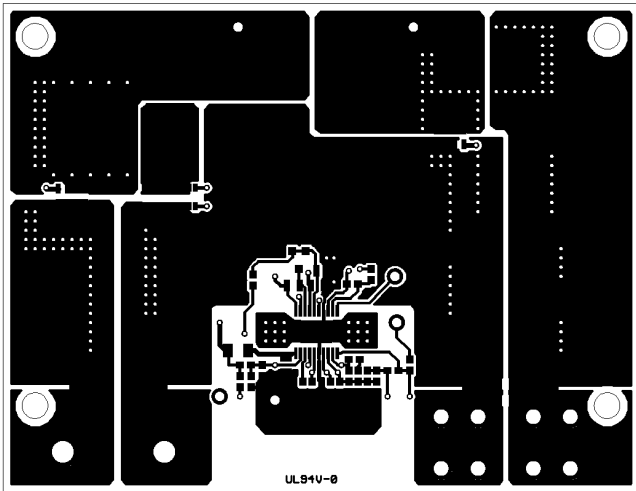

Top Layer as Viewed from Top

30057512

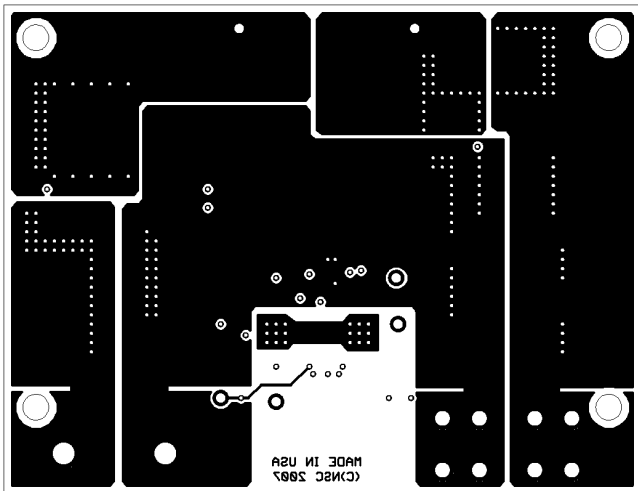

Bottom Layer as Viewed from Top

30057515

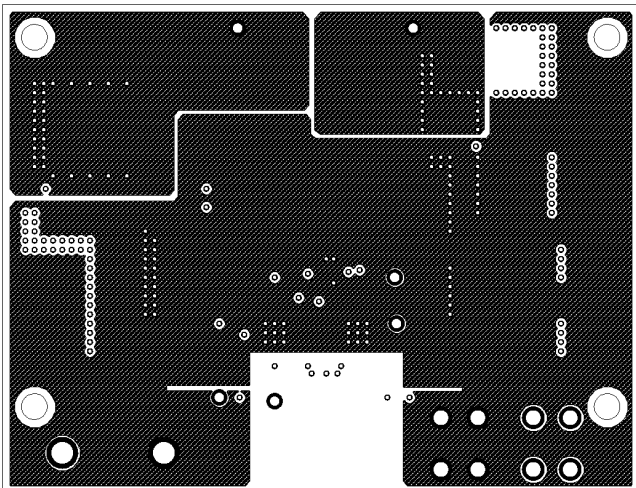

Layer 2 as Viewed from Top

30057513

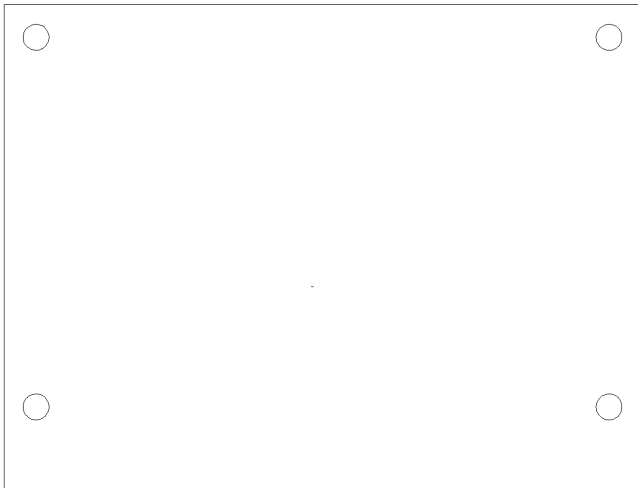

Bottom Silkscreen Layer as Viewed from Top

30057516

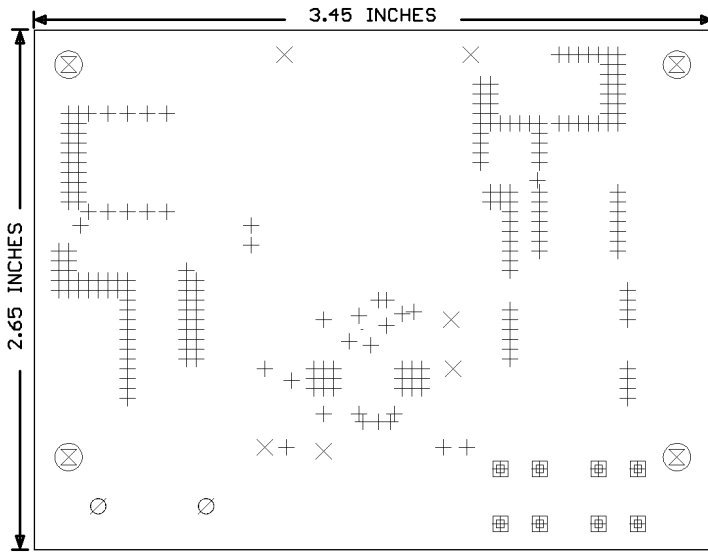

DRILL GUIDE	
+	0.014, +0.002, -0.002 INCHES
X	0.047, +0.005, -0.003 INCHES
□	0.076, +0.005, -0.005 INCHES
◇	0.115, +0.005, -0.005 INCHES
⊗	0.140, +0.008, -0.008 INCHES (NON-PLATED)

Drills and Dimensions as Viewed from Top

30057517



Notes

For more National Semiconductor product information and proven design tools, visit the following Web sites at:

Products		Design Support	
Amplifiers	www.national.com/amplifiers	WEBENCH	www.national.com/webench
Audio	www.national.com/audio	Analog University	www.national.com/AU
Clock Conditioners	www.national.com/timing	App Notes	www.national.com/appnotes
Data Converters	www.national.com/adc	Distributors	www.national.com/contacts
Displays	www.national.com/displays	Green Compliance	www.national.com/quality/green
Ethernet	www.national.com/ethernet	Packaging	www.national.com/packaging
Interface	www.national.com/interface	Quality and Reliability	www.national.com/quality
LVDS	www.national.com/lvds	Reference Designs	www.national.com/refdesigns
Power Management	www.national.com/power	Feedback	www.national.com/feedback
Switching Regulators	www.national.com/switchers		
LDOs	www.national.com/ldo		
LED Lighting	www.national.com/led		
PowerWise	www.national.com/powerwise		
Serial Digital Interface (SDI)	www.national.com/sdi		
Temperature Sensors	www.national.com/tempsensors		
Wireless (PLL/VCO)	www.national.com/wireless		

THE CONTENTS OF THIS DOCUMENT ARE PROVIDED IN CONNECTION WITH NATIONAL SEMICONDUCTOR CORPORATION ("NATIONAL") PRODUCTS. NATIONAL MAKES NO REPRESENTATIONS OR WARRANTIES WITH RESPECT TO THE ACCURACY OR COMPLETENESS OF THE CONTENTS OF THIS PUBLICATION AND RESERVES THE RIGHT TO MAKE CHANGES TO SPECIFICATIONS AND PRODUCT DESCRIPTIONS AT ANY TIME WITHOUT NOTICE. NO LICENSE, WHETHER EXPRESS, IMPLIED, ARISING BY ESTOPPEL OR OTHERWISE, TO ANY INTELLECTUAL PROPERTY RIGHTS IS GRANTED BY THIS DOCUMENT.

TESTING AND OTHER QUALITY CONTROLS ARE USED TO THE EXTENT NATIONAL DEEMS NECESSARY TO SUPPORT NATIONAL'S PRODUCT WARRANTY. EXCEPT WHERE MANDATED BY GOVERNMENT REQUIREMENTS, TESTING OF ALL PARAMETERS OF EACH PRODUCT IS NOT NECESSARILY PERFORMED. NATIONAL ASSUMES NO LIABILITY FOR APPLICATIONS ASSISTANCE OR BUYER PRODUCT DESIGN. BUYERS ARE RESPONSIBLE FOR THEIR PRODUCTS AND APPLICATIONS USING NATIONAL COMPONENTS. PRIOR TO USING OR DISTRIBUTING ANY PRODUCTS THAT INCLUDE NATIONAL COMPONENTS, BUYERS SHOULD PROVIDE ADEQUATE DESIGN, TESTING AND OPERATING SAFEGUARDS.

EXCEPT AS PROVIDED IN NATIONAL'S TERMS AND CONDITIONS OF SALE FOR SUCH PRODUCTS, NATIONAL ASSUMES NO LIABILITY WHATSOEVER, AND NATIONAL DISCLAIMS ANY EXPRESS OR IMPLIED WARRANTY RELATING TO THE SALE AND/OR USE OF NATIONAL PRODUCTS INCLUDING LIABILITY OR WARRANTIES RELATING TO FITNESS FOR A PARTICULAR PURPOSE, MERCHANTABILITY, OR INFRINGEMENT OF ANY PATENT, COPYRIGHT OR OTHER INTELLECTUAL PROPERTY RIGHT.

LIFE SUPPORT POLICY

NATIONAL'S PRODUCTS ARE NOT AUTHORIZED FOR USE AS CRITICAL COMPONENTS IN LIFE SUPPORT DEVICES OR SYSTEMS WITHOUT THE EXPRESS PRIOR WRITTEN APPROVAL OF THE CHIEF EXECUTIVE OFFICER AND GENERAL COUNSEL OF NATIONAL SEMICONDUCTOR CORPORATION. As used herein:

Life support devices or systems are devices which (a) are intended for surgical implant into the body, or (b) support or sustain life and whose failure to perform when properly used in accordance with instructions for use provided in the labeling can be reasonably expected to result in a significant injury to the user. A critical component is any component in a life support device or system whose failure to perform can be reasonably expected to cause the failure of the life support device or system or to affect its safety or effectiveness.

National Semiconductor and the National Semiconductor logo are registered trademarks of National Semiconductor Corporation. All other brand or product names may be trademarks or registered trademarks of their respective holders.

Copyright© 2008 National Semiconductor Corporation

For the most current product information visit us at www.national.com



**National Semiconductor
Americas Technical
Support Center**
Email: support@nsc.com
Tel: 1-800-272-9959

**National Semiconductor Europe
Technical Support Center**
Email: europe.support@nsc.com
German Tel: +49 (0) 180 5010 771
English Tel: +44 (0) 870 850 4288

**National Semiconductor Asia
Pacific Technical Support Center**
Email: ap.support@nsc.com

**National Semiconductor Japan
Technical Support Center**
Email: jpn.feedback@nsc.com