

CD4042B Types

CMOS

Quad Clocked "D" Latch High-Voltage Types (20-Volt Rating)

■ CD4042B types contain four latch circuits, each strobed by a common clock. Complementary buffered outputs are available from each circuit. The impedance of the n- and p-channel output devices is balanced and all outputs are electrically identical. Information present at the data input is transferred to outputs Q and \bar{Q} during the CLOCK level which is programmed by the POLARITY input. For POLARITY = 0 the transfer occurs during the 0 CLOCK level and for POLARITY = 1 the transfer occurs during the 1 CLOCK level. The outputs follow the data input providing the CLOCK and POLARITY levels defined above are present. When a CLOCK transition occurs (positive for POLARITY = 0 and negative for POLARITY = 1) the information present at the input during the CLOCK transition is retained at the outputs until an opposite CLOCK transition occurs.

The CD4042B types are supplied in 16-lead hermetic dual-in-line ceramic packages (D and F suffixes); 16-lead dual-in-line plastic package (E suffix), and in chip form (H suffix).

Features:

- Clock polarity control
- Q and \bar{Q} outputs
- Common clock
- Low power TTL compatible
- Standardized symmetrical output characteristics
- 100% tested for quiescent current at 20 V
- Maximum input current of 1 μ A at 18 V over full package-temperature range; 100 nA at 18 V and 25°C
- 5-V, 10-V, and 15-V parametric ratings
- Noise margin (over full package temperature range):
 - 1 V at $V_{DD} = 5$ V
 - 2 V at $V_{DD} = 10$ V
 - 2.5 V at $V_{DD} = 15$ V
- Meets all requirements of JEDEC Tentative Standard No. 13B, "Standard Specifications for Description of 'B' Series CMOS Devices"

Applications:

- Buffer storage
- Holding register
- General digital logic

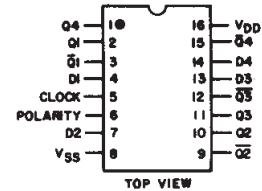
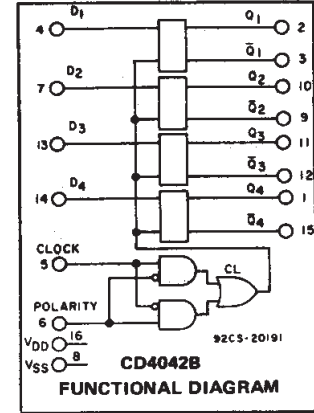

92CS-20756R1
TERMINAL ASSIGNMENT

STATIC ELECTRICAL CHARACTERISTICS

CHARACTERISTIC	CONDITIONS			LIMITS AT INDICATED TEMPERATURES (°C)							UNITS
	V_O (V)	V_{IN} (V)	V_{DD} (V)	-55	-40	+85	+125	+25			
								Min.	Typ.	Max.	
Quiescent Device Current, I_{DD} Max.	-	0,5	5	1	1	30	30	-	0.02	1	μ A
	-	0,10	10	2	2	60	60	-	0.02	2	
	-	0,15	15	4	4	120	120	-	0.02	4	
Output Low (Sink) Current, I_{OL} Min.	0.4	0,5	5	0.64	0.61	0.42	0.36	0.51	1	-	mA
	0.5	0,10	10	1.6	1.5	1.1	0.9	1.3	2.6	-	
	1.5	0,15	15	4.2	4	2.8	2.4	3.4	6.8	-	
Output High (Source) Current, I_{OH} Min.	4.6	0,5	5	-0.64	-0.61	-0.42	-0.36	-0.51	-1	-	mA
	2.5	0,5	5	-2	-1.8	-1.3	-1.15	-1.6	-3.2	-	
	9.5	0,10	10	-1.6	-1.5	-1.1	-0.9	-1.3	-2.6	-	
Output Voltage: Low-Level, V_{OL} Max.	-	0,5	5	0.05				-	0	0.05	V
	-	0,10	10	0.05				-	0	0.05	
	-	0,15	15	0.05				-	0	0.05	
Output Voltage: High-Level, V_{OH} Min.	-	0,5	5	4.95				4.95	5	-	V
	-	0,10	10	9.95				9.95	10	-	
	-	0,15	15	14.95				14.95	15	-	
Input Low Voltage, V_{IL} Max.	0.5,4.5	-	5	1.5				-	-	1.5	V
	1.9	-	10	3				-	-	3	
	1.5,13.5	-	15	4				-	-	4	
Input High Voltage, V_{IH} Min.	0.5,4.5	-	5	3.5				3.5	-	-	V
	1.9	-	10	7				7	-	-	
	1.5,13.5	-	15	11				11	-	-	
Input Current, I_{IN} Max.	-	0,18	18	± 0.1	± 0.1	± 1	± 1	-	$\pm 10^{-5}$	± 0.1	μ A

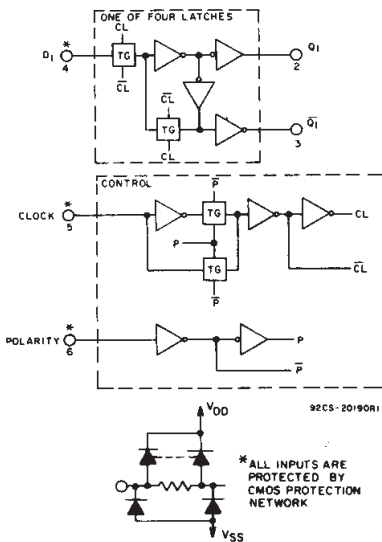

CLOCK	POLARITY	Q
0	0	D
	0	LATCH
1	1	D
	1	LATCH

Fig. 1 - Logic block diagram and truth table.

CD4042B Types

MAXIMUM RATINGS, Absolute-Maximum Values:

DC SUPPLY-VOLTAGE RANGE, (V_{DD})

Voltages referenced to V_{SS} Terminal) -0.5V to +20V

INPUT VOLTAGE RANGE, ALL INPUTS -0.5V to $V_{DD} + 0.5V$

DC INPUT CURRENT, ANY ONE INPUT $\pm 10mA$

POWER DISSIPATION PER PACKAGE (P_D):

For $T_A = -55^\circ C$ to $+100^\circ C$ 500mW

For $T_A = +100^\circ C$ to $+125^\circ C$ Derate Linearity at 12mW/ $^\circ C$ to 200mW

DEVICE DISSIPATION PER OUTPUT TRANSISTOR

FOR $T_A =$ FULL PACKAGE-TEMPERATURE RANGE (All Package Types) 100mW

OPERATING-TEMPERATURE RANGE (T_A) $-55^\circ C$ to $+125^\circ C$

STORAGE TEMPERATURE RANGE (T_{stg}) $-65^\circ C$ to $+150^\circ C$

LEAD TEMPERATURE (DURING SOLDERING):

At distance 1/16 \pm 1/32 inch (1.59 \pm 0.79mm) from case for 10s max $+265^\circ C$

RECOMMENDED OPERATING CONDITIONS at $T_A = 25^\circ C$, Except as Noted.
For maximum reliability, nominal operating conditions should be selected so that operation is always within the following ranges:

CHARACTERISTIC	V_{DD} (V)	LIMITS		UNITS
		Min.	Max.	
Supply-Voltage Range (For T_A =Full Package Temperature Range)	—	3	18	V
Clock Pulse Width, t_W	5	200	—	ns
	10	100	—	
	15	60	—	
Setup Time, t_S	5	50	—	ns
	10	30	—	
	15	25	—	
Hold Time, t_H	5	120	—	ns
	10	60	—	
	15	50	—	
Clock Rise or Fall Time: t_r, t_f	5, 10 15	Not rise or fall time sensitive.		μS

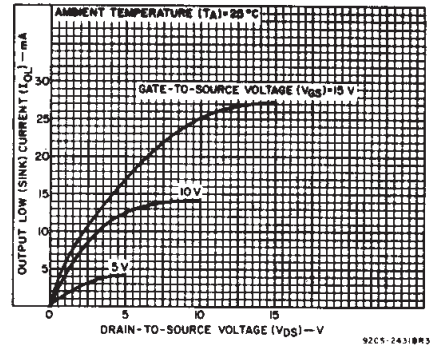

Fig. 2 - Typical output low (sink) current characteristics.

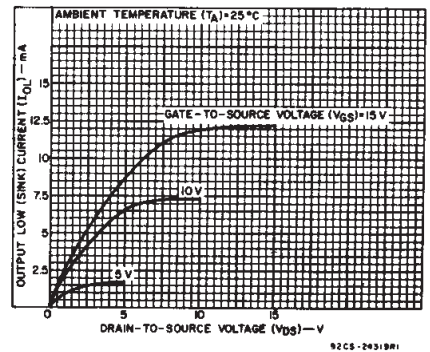

Fig. 3 - Minimum output low (sink) current characteristics.

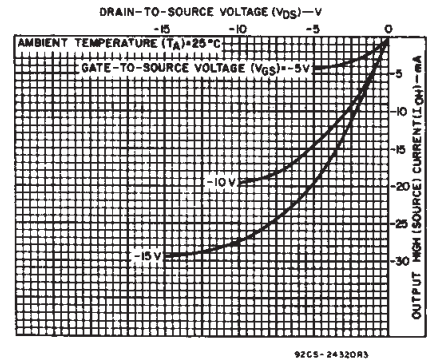

Fig. 4 - Typical output high (source) current characteristics.

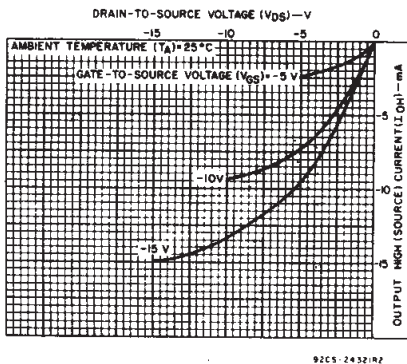

Fig. 5 - Minimum output high (source) current characteristics.

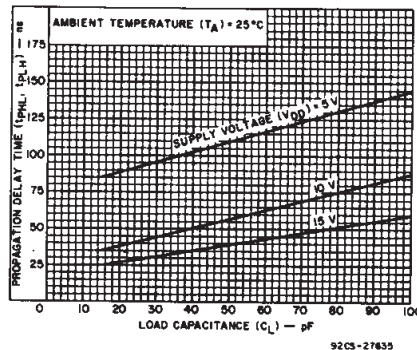

Fig. 6 - Typical propagation delay time vs. load capacitance—data to Q.

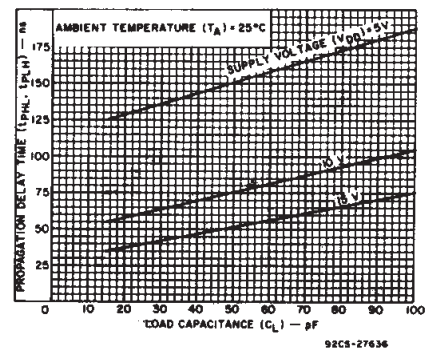

Fig. 7 - Typical propagation delay time vs. load capacitance—data to \bar{Q} .

3
COMMERCIAL CMOS
HIGH VOLTAGE ICs

CD4042B Types

DYNAMIC ELECTRICAL CHARACTERISTICS at $T_A = 25^\circ\text{C}$; Input $t_r, t_f = 20\text{ ns}$, $C_L = 50\text{ pF}$, $R_L = 200\text{ K}\Omega$

CHARACTERISTIC	VDD (V)	LIMITS		UNITS	
		Typ.	Max.		
Propagation Delay Time: t_{PHL}, t_{PLH} Data In to Q	5	110	220	ns	
	10	55	110		
	15	40	80		
Data In to \bar{Q}	5	150	300	ns	
	10	75	150		
	15	50	100		
Clock to Q	5	225	450	ns	
	10	100	200		
	15	80	160		
Clock to \bar{Q}	5	250	500	ns	
	10	115	230		
	15	90	180		
Transition Time: t_{THL}, t_{TLH}	5	100	200	ns	
	10	50	100		
	15	40	80		
Minimum Clock Pulse Width, t_W	5	100	200	ns	
	10	50	100		
	15	30	60		
Minimum Hold Time, t_H	5	60	120	ns	
	10	30	60		
	15	25	50		
Minimum Setup Time, t_S	5	0	50	ns	
	10	0	30		
	15	0	25		
Clock Input Rise or Fall Time: t_r, t_f	5, 10, 15	Not rise or fall time sensitive.		μs	
Input Capacitance, C_{IN}	-	Polarity Input	5	7.5	pF
		All Other Inputs	7.5	15	pF

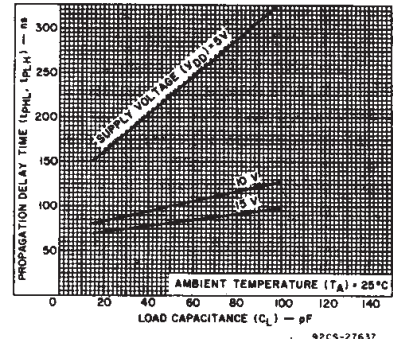

Fig. 8 - Typical propagation delay time vs. load capacitance—clock to Q

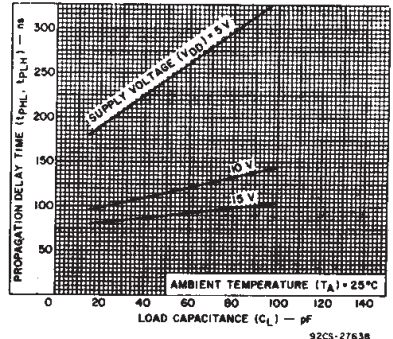
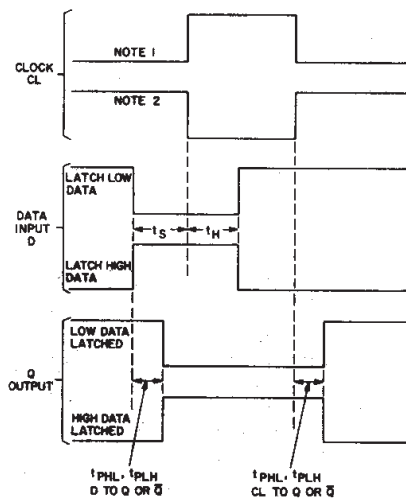

Fig. 9 - Typical propagation delay time vs. load capacitance—clock to \bar{Q} .



NOTES:
1. FOR POSITIVE CLOCK EDGE, INPUT DATA IS LATCHED WHEN POLARITY IS LOW.
2. FOR NEGATIVE CLOCK EDGE, INPUT DATA IS LATCHED WHEN POLARITY IS HIGH.

92CS-27630

Fig. 12 - Dynamic test parameters.

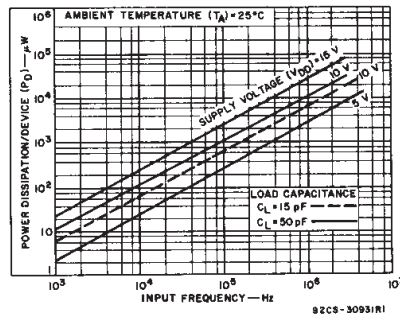
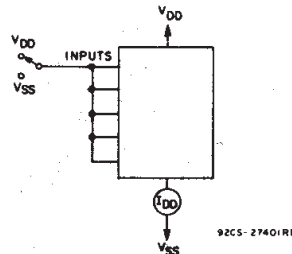

Fig. 10 - Typical power dissipation vs. frequency.



92CS-27401R1

Fig. 13 - Quiescent device current test circuit.

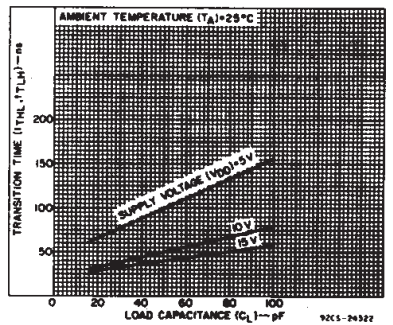
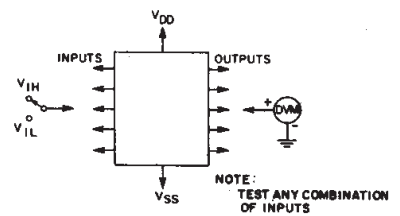

Fig. 11 - Typical transition time vs. load capacitance.



92CS-27441R1

Fig. 14 - Input voltage test circuit.

CD4042B Types

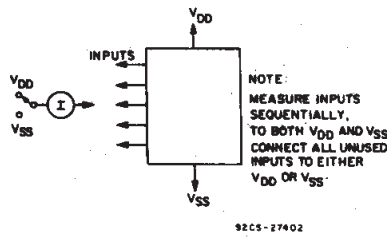
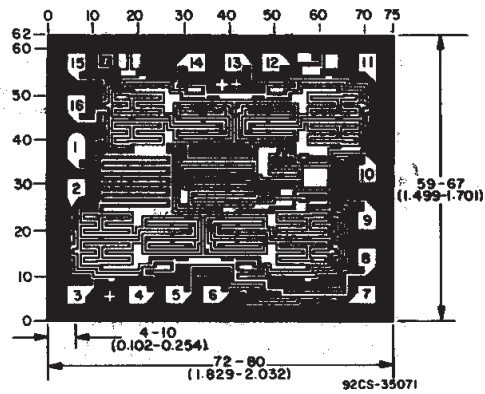

Fig. 15 - Input current test circuit.

Chip Dimensions and Pad Layout



Dimensions in parentheses are in millimeters and are derived from the basic inch dimensions as indicated. Grid graduations are in mils (10^{-3} inch).

IMPORTANT NOTICE

Texas Instruments and its subsidiaries (TI) reserve the right to make changes to their products or to discontinue any product or service without notice, and advise customers to obtain the latest version of relevant information to verify, before placing orders, that information being relied on is current and complete. All products are sold subject to the terms and conditions of sale supplied at the time of order acknowledgement, including those pertaining to warranty, patent infringement, and limitation of liability.

TI warrants performance of its semiconductor products to the specifications applicable at the time of sale in accordance with TI's standard warranty. Testing and other quality control techniques are utilized to the extent TI deems necessary to support this warranty. Specific testing of all parameters of each device is not necessarily performed, except those mandated by government requirements.

CERTAIN APPLICATIONS USING SEMICONDUCTOR PRODUCTS MAY INVOLVE POTENTIAL RISKS OF DEATH, PERSONAL INJURY, OR SEVERE PROPERTY OR ENVIRONMENTAL DAMAGE ("CRITICAL APPLICATIONS"). TI SEMICONDUCTOR PRODUCTS ARE NOT DESIGNED, AUTHORIZED, OR WARRANTED TO BE SUITABLE FOR USE IN LIFE-SUPPORT DEVICES OR SYSTEMS OR OTHER CRITICAL APPLICATIONS. INCLUSION OF TI PRODUCTS IN SUCH APPLICATIONS IS UNDERSTOOD TO BE FULLY AT THE CUSTOMER'S RISK.

In order to minimize risks associated with the customer's applications, adequate design and operating safeguards must be provided by the customer to minimize inherent or procedural hazards.

TI assumes no liability for applications assistance or customer product design. TI does not warrant or represent that any license, either express or implied, is granted under any patent right, copyright, mask work right, or other intellectual property right of TI covering or relating to any combination, machine, or process in which such semiconductor products or services might be or are used. TI's publication of information regarding any third party's products or services does not constitute TI's approval, warranty or endorsement thereof.