

**DISPLAY Elektronik GmbH**

# DATA SHEET

**1,8" TFT  
MODULE**

**DEM 128160B TMH-PW-N**

**Product Specification**

**Version: 1.0**

**31.10.2007**

REVISION HISTORY:				
Revision	Date	Description	Written By	Approved By
1.0	30.10.2007	New Release	XH	MH

# **CONTENTS**

- 1.0 GENERAL SPECIFICATION**
- 2.0 OUTLINE DRAWING**
- 3.0 INTERFACE PIN CONNECTION**
- 4.0 BLOCK DIAGRAM**
- 5.0 ABSOLUTE MAXIMUM RATINGS**
- 6.0 ELECTRICAL CHARACTERISTICS**
- 7.0 OPTICAL CHARACTERISTICS**
- 8.0 BACKLIGHT SPECIFICATION**
- 9.0 STANDARD SPECIFICATION FOR RELIABILITY**
- 10.0 QUALITY ASSURANCE**
- 11.0 PRECAUTIONS FOR USING LCD MODUL**
- 12.0 LOT NUMBERING SYSTEM**
- 13.0 RoHS COMPLIANT PRODUCT**
- 14.0 LIMITED WARRANTY**
- 15.0 APPENDIX**

**1.0 GENERAL SPECIFICATION**

<b>Item</b>	<b>Contents</b>	<b>Unit</b>
LCD Type	1.8 Inch a-Si TFT-Color Transmissive	-
Module Dimension	34.00 x 45.78 x 3.55	mm
Active Display Area	28.032 x 35.040	mm
Number of dots	128xRGBx160	dots
Dot Pitch	0.073 x 0.219	mm
Pixel Pitch	0.219 x 0.219	mm
Color-filter-array	RGB Stripe	-
Number Of Colors	262k	-
Viewing Direction	6	o'clock
Backlight	LED back-light / White / Lightguide / Long-Lifetime	-
Driver IC	HX8345-A (HIMAX)	-
MPU interface	16-bit (80-System/68-System) 18-bit (80-System/68-System)	See below remark
Operating Temperature	-20 ~ 70	°C
Storage Temperature	-30 ~ 80	°C
Weight	~ 7	g

Remark: Below interfaces can be custom-made according to different applications:

- 80-system interface (8-/9-/16-/18-bit bus)
- 68-system interface (8-/9-/16-/18-bit bus)
- Serial Data Transfer Interface
- RGB interface (6-/16-/18-bit bus)
- VSYNC data transfer interface

2.0 OUTLINE DRAWING

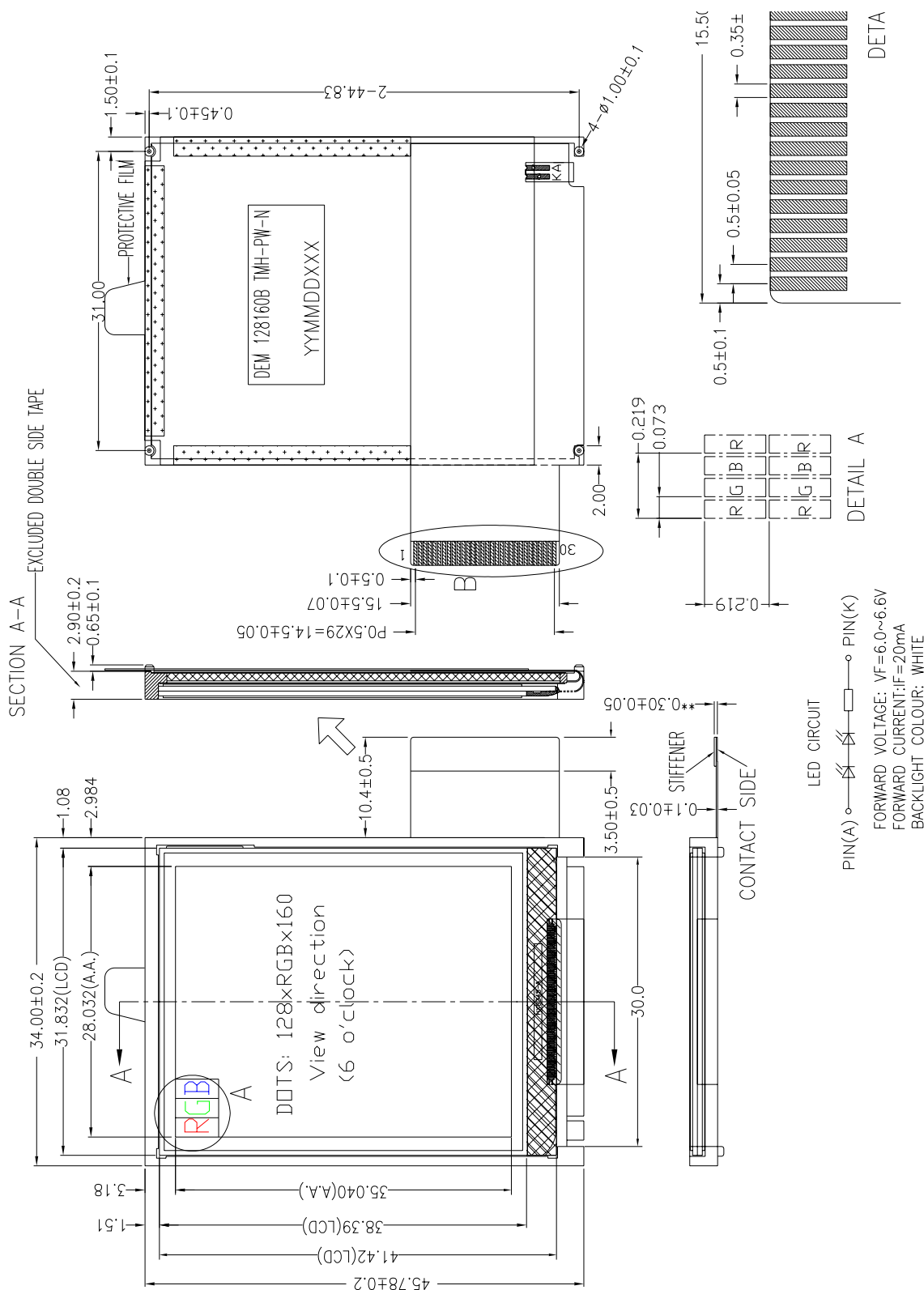

3.0 INTERFACE PIN CONNECTION

No	Port	Function	I/O
1	A	Anode of the backlight.	-
2	K	Cathode of the backlight.	P
3	VCI	Analog power supply.	P
4	IOVCC	Logic power supply.	I
5	GND	Power ground.	I
6	CS	Chip select pin, low active.	I
7	RS	Register index or register command selection pin.	I
8	WR	Write enable pin.	I
9	RD	Read enable pin.	I
10 ~ 27	D0 ~ D17	Bi-directional data bus.	I/O
28	RESET	Reset pin, low active.	I
29	IM3	16-bit or 18-bit interface selection. IM3=0: 16-bit IM3=1: 18-bit	I
30	IM0	Select 80 or 68 mode IM1=0: 68mode IM1=1: 80 mode.	I

4.0 BLOCK DIAGRAM

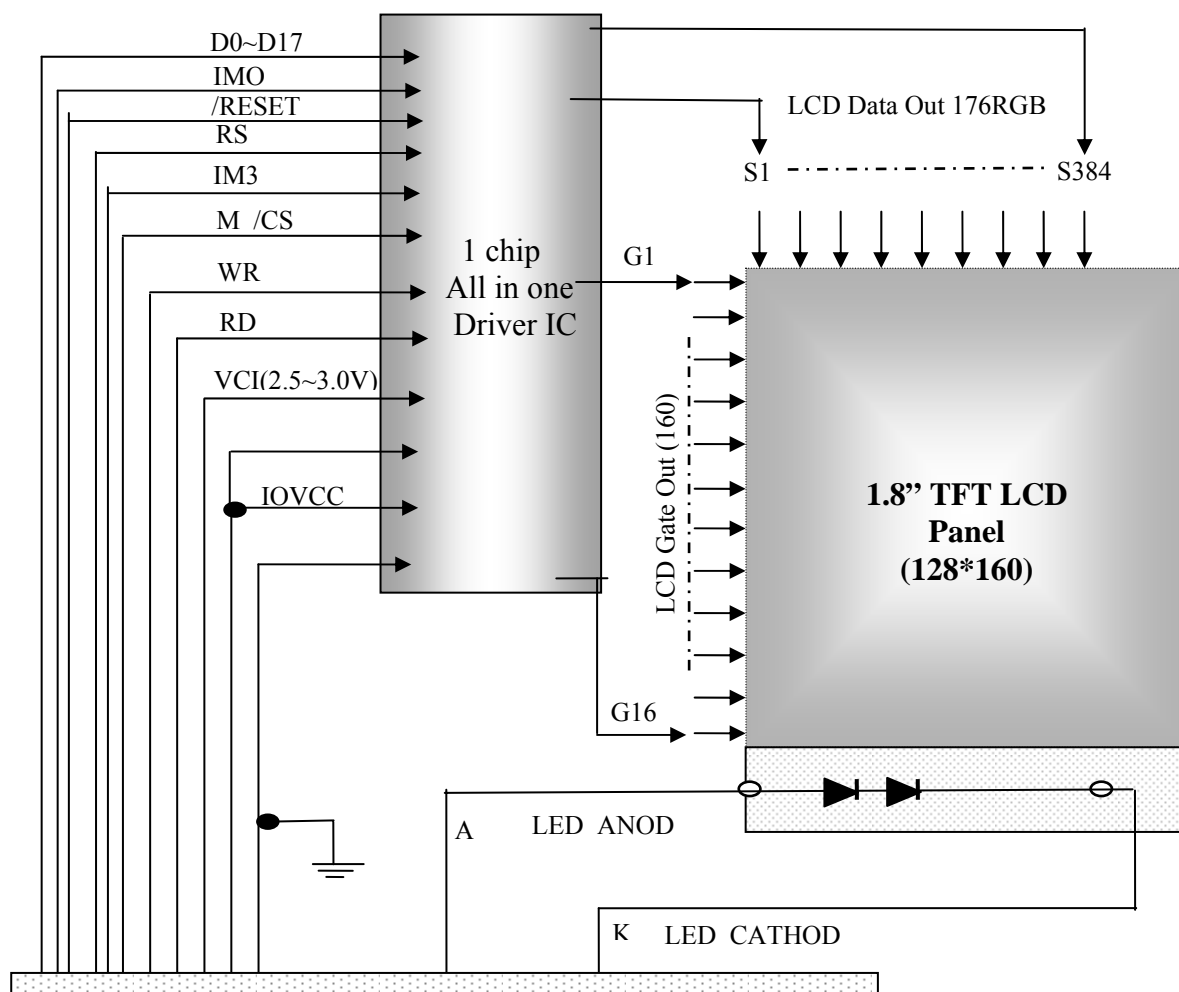

**5.0 ABSOLUTE MAXIMUM RATINGS** ( $T_a = 25 \pm 2^\circ\text{C}$ ,  $V_{SS}=\text{GND}$ )

Item	Symbol	Value	Unit	Note
Power supply voltage(1)	IO V <sub>CC</sub> , V <sub>CC</sub>	-0.3 to +4.6	V	1, 2
Power supply voltage(2)	V <sub>CI</sub> ~ GND	-0.3 to +4.6	V	1, 2
Power supply voltage(3)	V <sub>LCD</sub> ~ GND	-0.3 to +6.0	V	3
Power supply voltage(4)	GND ~ V <sub>CL</sub>	-0.3 to +4.6	V	4
Power supply voltage(5)	V <sub>LCD</sub> ~ V <sub>CL</sub>	-0.3 to +9	V	5
Power supply voltage(6)	V <sub>GH</sub> ~ GND	-0.3 to +18.5	V	6
Power supply voltage(7)	GND ~ V <sub>GL</sub>	-0.3 to +18.5	V	7
Input Voltage	V <sub>i</sub>	-0.3 to V <sub>CC</sub> +0.3	V	-

Notes :

1. V<sub>CC</sub>, V<sub>SSD</sub> must be maintained.
2. To make sure IOV<sub>CC</sub> ≥ V<sub>SSD</sub>.
3. To make sure V<sub>CI</sub> ≥ V<sub>SSA</sub>.
4. To make sure V<sub>LCD</sub> ≥ V<sub>SSA</sub>.
5. To make sure V<sub>LCD</sub> ≥ V<sub>CL</sub>.
6. To make sure V<sub>GH</sub> ≥ V<sub>SSA</sub>.
7. To make sure V<sub>SSA</sub> ≥ V<sub>GL</sub>.

**6.0 ELECTRICAL CHARACTERISTICS**

Item	Symbol	Unit	Test Condition	Min.	Typ.	Max.	Note
Input high voltage	V <sub>IH</sub>	V	IOV <sub>CC</sub> = 1.65 ~ 3.3V	0.8xIOV <sub>CC</sub>	-	IOV <sub>CC</sub>	-
Input low voltage	V <sub>IL</sub>	V	IOV <sub>CC</sub> = 1.65 ~ 3.3V	-0.3V	-	0.2xIOV <sub>CC</sub>	-
Output high voltage (1) (DB0-17 Pins)	V <sub>OH1</sub>	V	I <sub>OH</sub> = -0.1 mA	0.8xIOV <sub>CC</sub>	-	-	-
Output low voltage (DB0-17 Pins)	V <sub>OL1</sub>	V	IOV <sub>CC</sub> = 1.65 ~ 2.4V I <sub>OL</sub> = 0.1mA	-	-	0.2xIOV <sub>CC</sub>	-
I/O leakage current	I <sub>Li</sub>	μA	V <sub>in</sub> = 0 ~ V <sub>CC</sub>	-1	-	1	-
Current consumption during normal operation ( V <sub>CC</sub> – V <sub>SSD</sub> )+ (IOV <sub>CC</sub> -V <sub>SSD</sub> )	I <sub>OP</sub> (V <sub>CC</sub> )	μA	V <sub>CI</sub> =IOV <sub>CC</sub> =V <sub>CC</sub> =2.8V , T <sub>a</sub> =25°C , f <sub>OSC</sub> = 330KHz (220 Line) GRAM data = 0000h, Frame rate = 70Hz, REV=0, SAP=100, AP=100, DC0=000, DC1=010,B/C=0, BT=001, VC=001, VRH=0011, VCM=10011,VDV=10000, VCOMG=1, CL=0, No panel load	-	150	300	-
Current consumption during normal operation ( V <sub>CI</sub> – V <sub>SSD</sub> )	I <sub>OP</sub> (V <sub>CI</sub> )	mA			1.4	1.8	
Current consumption during standby mode ( V <sub>CC</sub> – V <sub>SSD</sub> ) + (IOV <sub>CC</sub> -V <sub>SSD</sub> )	I <sub>ST</sub> (V <sub>CC</sub> )	μA	V <sub>CC</sub> =2.8V , T <sub>a</sub> =25C	-	1	10	-
Current consumption during standby mode ( V <sub>CI</sub> – V <sub>SSD</sub> )	I <sub>ST</sub> (V <sub>CI</sub> )	μA			0.5	1	
Output voltage deviation	-	mV	-	-	5	-	-
Dispersion of the Average Output Voltage	V	mV	-	-	-	35	

**7.0 OPTICAL CHARACTERISTICS**

No	Item	Symbol	Condition	Min.	Typ.	Max.	Unit	Note	
1	Response Time	Tr	$\theta = \phi = 0^\circ$	-	10	20	ms	(1)	
		Tf		-	20	30			
2	Contrast Ratio	CR	$\theta = \phi = 0^\circ$	150	250	-	-	(2)	
3	Viewing Angle (CR $\geq 10$ )	Right	$\phi = 0^\circ$	-	45	-	Deg	(3)	
		Left	$\phi = 180^\circ$	-	45	-	Deg		
		Upper	$\phi = 90^\circ$	-	35	-	Deg		
		Lower	$\phi = 270^\circ$	-	15	-	Deg		
4	Luminance of white(Center point)	L		250	300	-	Cd/m <sup>2</sup>	(5)	
5	Color Chromaticity (CIE1931)	Red	Rx	$\theta = \phi = 0^\circ$	0.611	0.641	0.671	-	(4)
			Ry		0.315	0.345	0.375	-	
		Green	Gx		0.266	0.296	0.326	-	
			Gy		0.554	0.584	0.614	-	
		Blue	Bx		0.102	0.132	0.162	-	
			By		0.106	0.136	0.166	-	
		White	Wx		0.279	0.309	0.339	-	
			Wy		0.318	0.348	0.378	-	
6	Optimum Viewing Direction	6 o'clock						-	

Note (1): Definition of Response Time

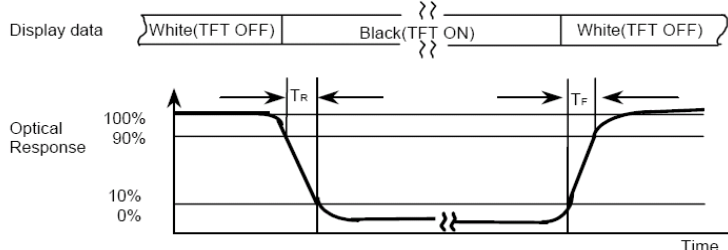

Note (3): Definition of Viewing

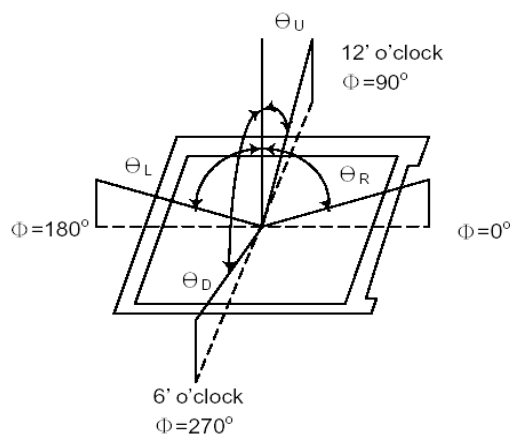

Note (2): Definition of Contrast Ratio

CR = Brightness at all pixels "White" / Brightness at all pixels "Black"

Note (4): Measured at center point vertically with backlight on.

Note(5):After stabilizing and leaving the panel alone at a given temperature for 30 min ,the measurement should be executed .Measurement should be executed in a stable, windless, and dark room. 30 min after lighting the back-light. This should be measured in the center of screen.

Environment condition: Ta=25±2°C Back-Light On condition

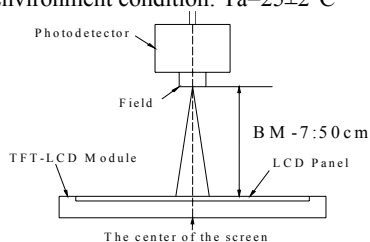



**8.0 BACKLIGHT SPECIFICATION**

Item	Symbol	Min.	Typ.	Max.	Unit	Conditions
Forward voltage	Vf	6.0	6.3	6.6	V	If = 20 mA
Absolute Max. Forward Current	Ifm	20	-	35	mA	-
Reverse current	Ir	-	-	15	uA	Vr = 3.0V
Chromaticity coordinates	X	0.275	-	0.310	-	
	Y	0.275	-	0.310	-	
Luminance (BLU only)	Lv	3000	3500	4200	cd/m <sup>2</sup>	If = 20 mA
Uniformity	Δ	80	85	-	%	Min/max*100%
Remark	Patented LED					
Half-Brightness Life Time	50000 Hours					

**9.0 STANDARD SPECIFICATION FOR RELIABILITY**

**9.1 Standard Specification of Reliability Test**

No	Test Item	Content of Test	Test Condition	Applicable Standard
1	High temperature storage	Endurance test applying the high storage temperature for a long time.	80+/-3 °C 240 hrs	-----
2	Low temperature storage	Endurance test applying the low storage temperature for a long time.	-30+/-3 °C 240 hrs	-----
3	High temperature operation	Endurance test applying the electric stress (Voltage & Current) and the thermal stress to the element for a long time.	70+/-3 °C 240 hrs	-----
4	Low temperature operation	Endurance test applying the electric stress under low temperature for a long time.	-20+/-3 °C 240 hrs	-----
5	High temperature / Humidity operation	Endurance test applying the electric stress (Voltage & Current) and temperature / humidity stress to the element for a long time.	40 °C , 90 %RH 120 hrs	MIL-202E-103B JIS-C5023
6	Temperature cycle	Endurance test applying the low and high temperature cycle.  $  \begin{array}{c}  -20^{\circ}\text{C} \xrightarrow{30\text{min.}} 25^{\circ}\text{C} \xrightarrow{5\text{min.}} 70^{\circ}\text{C} \\  \xleftarrow{30\text{min.}} \quad \quad \quad \xleftarrow{30\text{min.}} \\  \text{1 cycle}  \end{array}  $	-20°C / 70°C 10 cycles	-----
Mechanical Test				
7	Drop Test	Endurance test applying the drop during transportation.	Packed, 100cm free fall (6 sides, 1 corner, 3edges)	----

Remarks:

- 1) For operation test, above specification is applicable when test pattern is changing during entire operation test.
- 2) Inspections after reliability tests are performed when the display temperature resumes back to room temperature.
- 3) It is a normal characteristic that some display abnormality can be seen during reliability test. If the display abnormality can resume back to normal condition at room temperature within 24hours, there is no permanent destruction over the display. The display still possesses its functionality after reliability tests.

**9.2 Failure Judgment Criteria**

After the reliability tests above, test sample shall be let return to room temperature and humidity for at least 4 hours before final tests are carried out.

Criterion Item	Failure Judgment Criteria
Electrical characteristic	Electrical short and open.
Mechanical characteristic	Out of mechanical specification
Optical characteristic	Out of the Appearance Standard

**10.0 QUALITY ASSURANCE**

**10.1 Acceptable Quality Level (AQL)**

Each lot should satisfy the quality level defined as follows:

- a) Inspection method: MIL-STD-105E Level II normal one time sampling
- b) AQL level

Category	AQL	Definition
Major	0.25%	Functional defective as product
Minor	1.00%	Satisfy all functions as product but not satisfy cosmetic standard

**10.2 Cosmetic Screening Criteria**

No	Defect	Judgment Criteria	Category		
1	Spots/Dust /Bubble (Round type)	Size, d (mm)	Acceptable quantity in active area	Minor	
		$d \leq 0.15$	Disregard		
		$0.15 < d \leq 0.20$	3		
		$d > 0.20$	0		
2	Dust/Scratches/ Black streak (Line type)	Width, W (mm)	Length, L (mm)	Acceptable quantity in active area	Minor
		$W \leq 0.02$	Disregard	Disregard	
		$W \leq 0.03$	$L \leq 1.0$	Disregard	
		$W \leq 0.05$	$L \leq 2.0$	3	
		$W > 0.05$	Disregard	0	
3	Allowable density	Above defects should be separated more than 5mm each other.	Minor		
4	Rainbow	Obvious uneven color (rainbow) shall not be noticeable.	Minor		
5	Display condition	Dim display on the patterns, extra pattern and short circuit are not acceptable.	Major		
6	No display or missing display	The patterns of display shall light up as required. No display or missing display are not acceptable.	Major		

Note:  $d = (\text{long length} + \text{short length}) / 2$

**11.0 PRECAUTIONS FOR USING LCD MODULE****Handling Precautions**

- The display panel is made of glass and polarizer. Do not subject it to mechanical shock by dropping or impact which may cause chipping especially on the edges.
- Do not touch, push or rub the exposed polarizers with anything harder than an HB pencil lead (glass, tweezers, etc.). The polarizer covering the display surface of the LCD module is soft and easily scratched. Handle this polarizer carefully.
- If the display surface becomes contaminated, breathe on the surface and gently wipe it with a soft dry cloth. If it is heavily contaminated, moisten cloth with Isopropyl alcohol or ethyl alcohol. Avoid using solvents like acetone (ketene), water, toluene, ethanol to clean the polarizer surface.
- Please keep the temperature within specified range for use and storage. Polarization degradation, bubble generation or polarizer peel-off may occur with high temperature and high humidity.
- Do not apply excessive force to the display surface or the adjoining areas since this may cause the color tone to vary.
- Install the LCD Module by using the mounting holes. When mounting the LCD module make sure it is free of twisting, warping and distortion.
- Exercise care to minimize corrosion of the electrode. Corrosion of the electrodes is accelerated by water droplets, moisture condensation or a current flow in a high-humidity environment.
- NC terminal should be open. Do not connect anything.
- If the logic circuit power is off, do not apply the input signals.
- Avoid contacting oil and fats.
- Condensation on the surface and contact with terminals due to cold will damage, stain or dirty the polarizers. After products are tested at low temperature they must be warmed up in a container before coming is contacting with room temperature air.
- Wipe off saliva or water drops immediately, contact with water over a long period of time may cause deformation or color fading.

**Electro-Static Discharge Control**

- Since this module uses a CMOS LSI, the same careful attention should be paid to electrostatic discharge as for an ordinary CMOS IC.
- Be sure to ground the body when handling the LCD modules. Tools required for assembling, such as soldering irons, must be properly grounded.
- To reduce the amount of static electricity generated, do not conduct assembling and other work under dry conditions. To reduce the generation of static electricity, be careful that the air in the work is not too dried. A relative humidity of 50%-60% is recommended.
- The LCD module is coated with a film to protect the display surface. Exercise care when peeling off this protective film since static electricity may be generated.
- When soldering the terminal of LCM, make certain the AC power source for the soldering iron does not leak.

**Precaution for soldering to the LCM**

- Observe the following when soldering lead wire, connector cable and etc. to the LCD module.
  - Soldering iron temperature: 300 ~ 350°C. Soldering time: ≤ 3 sec. Solder: eutectic solder. Above is a recommended approach. Due to different solder composition and processing method, it is recommended that customer to study and fine tuning their soldering process parameters accordingly.
- If soldering flux is used, be sure to remove any remaining flux after finishing to soldering operation. (This does not apply in the case of a non-halogen type of flux.) It is recommended that you protect the LCD surface with a cover during soldering to prevent any damage due to flux spatters.

**Precautions for Operation**

- Viewing angle varies with the change of liquid crystal driving voltage ( $V_O$ ). Adjust  $V_O$  to show the best contrast.
- Driving the LCD in the voltage above the limit shortens its lifetime.
- Response time is greatly delayed at temperature below the operating temperature range. However, it will recover when it returns to the specified temperature range.
- If the display area is pushed hard during operation, the display will become abnormal. However, it will return to normal if it is turned off and then back on.
- When turning the power on, input each signal after the positive/negative voltage becomes stable

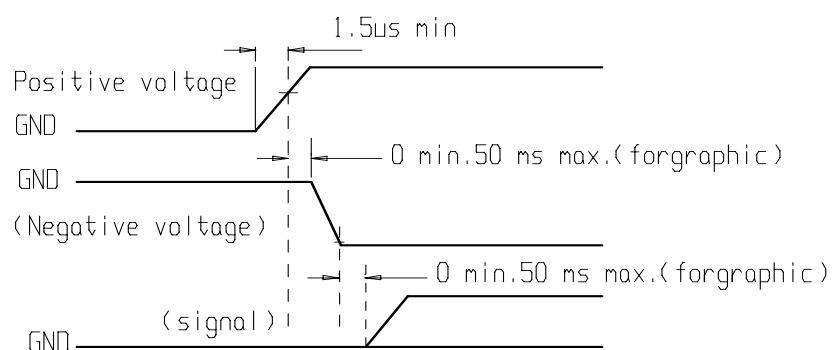
**Storage**

- When storing LCDs as spares for some years, the following precautions are necessary.
- Store them in a sealed polyethylene bag. If properly sealed, there is no need for desiccant.
- Store them in a dark place. Do not expose to sunlight or fluorescent light, keep the temperature between 0°C and 35°C.
- Environmental conditions:
- Do not leave them for more than 168hrs. at 60°C.
- Should not be left for more than 48hrs. at -20°C.

**Safety**

- It is recommended to crush damaged or unnecessary LCD into pieces and wash them off with solvents such as acetone and ethanol, which should later be burned.
- If any liquid leaks out of a damaged glass cell and comes in contact with the hands, wash off thoroughly with soap and water.

**12.0 LOT NUMBERING SYSTEM**

**12.1 One lot means the delivery date and times to customer at one time.**

YYMMDD XXX  
(1) (2)

- (1) Manufacturing date (COG bonding) (YY: Year, MM: Month, DD: Day)
- (2) Serial number starts from A01, A02.....,A99, B01, B02.....

**12.2 Location of lot number**

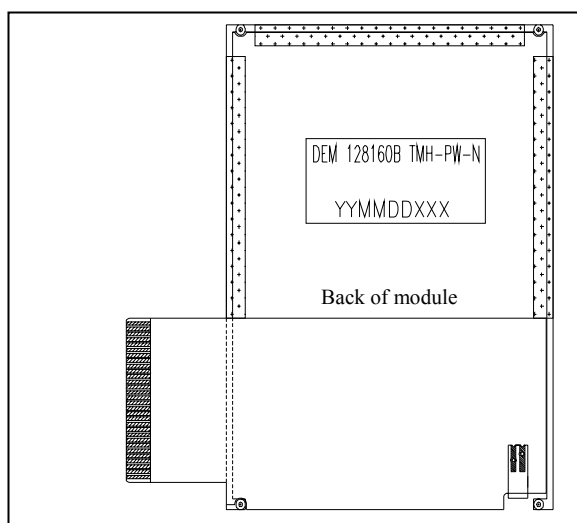

Datecode ←

Remarks:  
This datecode is meant for traceability purpose and will not affect functionality of the display module. Thus, there is no special control on the font type and font size of the datecode as long as it is visible and readable.  
Please refer to outline drawing for datecode orientation and its content.

**13.0 ROHS COMPLIANT PRODUCT**

**Standard of specific chemical substance**

- |                                           |                   |
|-------------------------------------------|-------------------|
| 1. Cadmium and Cadmium Compounds          | Less than 100ppm  |
| 2. Hexavalent Chromium Compounds          | Less than 1000ppm |
| 3. Lead and Lead Compounds                | Less than 1000ppm |
| 4. Mercury and Mercury Compounds          | Less than 1000ppm |
| 5. Polybrominated Biphenyls (PBBs)        | Less than 1000ppm |
| 6. Polybrominated Diphenyl ethers (PBDEs) | Less than 1000ppm |

**14.0 LIMITED WARRANTY**

Please inspect the LCD modules within one month after your receipt. Unless agreed between DISPLAY and customer, DISPLAY will replace or repair any of its LCD modules, which are found to be functionally defective when inspected in accordance with DISPLAY LCD/LCM acceptance standards (copies available upon request) for a period of one year from date of shipments. Cosmetic/visual defects must be returned to DISPLAY within 90 days of shipment. Confirmation of such date shall be based on freight documents. The warranty liability of DISPLAY limited to repair and/or replacement on the terms set forth above. DISPLAY will not be responsible for any subsequent or consequential events.

**15.0 APPENDIX: OPERATING PRINCIPLE & DRIVING METHOD**

- 15.1 Please refer to HX8345 IC datasheet for more details.
- 15.2 HX8345 Instruction Description.

# DEM 240320A TMH-PW-N

# Product Specification

## Appendix: HX8340 Instruction Sets

Register No.	Register	E_NW	RS	Upper Code								Lower Code								Instructions	
				RB15	RB14	RB13	RB12	RB11	RB10	RB9	RB8	RB7	RB6	RB5	RB4	RB3	RB2	RB1	RB0		
IR	Index	W	0	*	*	*	*	*	*	*	*	*	*	ID6	ID5	ID4	ID3	ID2	ID1	ID0	
SR	Status Read	R	0	L7	L6	L5	L4	L3	L2	L1	L0	0	0	0	0	0	0	0	0	0	OSC_EN (1)
R00h	Start Oscillation	W	1	*	*	*	*	*	*	*	*	*	*	*	*	*	*	*	*	*	
R00h	Device Code Read	R	1	0	0	0	0	0	0	1	1	0	1	0	0	0	0	0	0	0	
R01h	Driver Output Control (1)	W	1	0	0	0	0	0	SM (0)	GS (0)	SS (0)	0	0	0	NL4 (1)	NL3 (0)	NL2 (0)	NL1 (0)	NL0 (1)		
R02h	LCD AC driving Control	W	1	0	0	0	0	0	FLD0 (1)	FLD0 (1)	BC (0)	ECR (0)	0	NW5 (0)	NW4 (0)	NW3 (0)	NW2 (0)	NW1 (0)	NW0 (0)		
R03h	Power Control (1)	W	1	0	0	0	0	0	BT1 (0)	BT0 (0)	DC02 (0)	DC01 (0)	DC00 (0)	AP2 (0)	AP1 (0)	AP0 (0)	SLP (0)	STB (0)			
R05h	Entry Mode	W	1	0	0	0	0	BGR (0)	0	0	0	0	0	ID1 (1)	ID0 (0)	AM (0)	LG2 (0)	LG1 (0)	LG0 (0)		
R06h	16-bits Compare Register	W	1	CP15 (0)	CP14 (0)	CP13 (0)	CP12 (0)	CP11 (0)	CP10 (0)	CP9 (0)	CP8 (0)	CP7 (0)	CP6 (0)	CP5 (0)	CP4 (0)	CP3 (0)	CP2 (0)	CP1 (0)	CP0 (0)		
R07h	Display Control (1)	W	1	0	0	0	0	0	PT1 (0)	PT0 (0)	VLE2 (0)	VLE1 (0)	SPT (0)	0	GON (0)	DTE (0)	CL (0)	REV (0)	D1 (0)	D0 (0)	
R08h	Display Control (2)	W	1	VSPL (0)	HSPL (0)	DPL (0)	EPL (0)	FP3 (0)	FP2 (0)	FP1 (1)	FP0 (1)	ISC3 (0)	ISC2 (0)	ISC1 (0)	ISC0 (0)	BP3 (0)	BP2 (1)	BP1 (0)	BP0 (1)		
R09h	Power Control (2)	W	1	0	0	0	0	0	0	DCM1 (0)	DCM0 (0)	DC12 (0)	DC11 (0)	DC10 (0)	0	DK (0)	SAP2 (0)	SAP1 (1)	SAP0 (1)		
R0Ah	External Display Interface Control 1	W	1	TR1 (0)	DFM1 (0)	DFM0 (0)	0	0	PTG1 (0)	PTG0 (0)	RM (0)	0	0	DM1 (0)	DM0 (0)	0	0	RIM1 (0)	RIM0 (0)		
R0Bh	Frame Cycle Control	W	1	GD1 (0)	GD0 (0)	SDT1 (0)	SDT0 (0)	CE1 (0)	CE0 (0)	DIV1 (0)	DIV0 (0)	0	0	0	0	0	RTN3 (0)	RTN2 (0)	RTN1 (0)	RTN0 (0)	
R0Ch	Power Control (3)	W	1	0	0	0	0	0	0	0	0	0	0	0	0	0	VC2 (0)	VC1 (0)	VC0 (0)		
R0Dh	Power Control (4)	W	1	0	0	0	0	0	0	0	0	0	0	0	0	0	VRH3 (0)	VRH2 (0)	VRH1 (0)	VRH0 (0)	
R0Eh	Power Control (5)	W	1	0	0	VCOMG (0)	VDV4 (0)	VDV3 (0)	VDV2 (0)	VDV1 (0)	VDV0 (0)	0	0	0	0	0	VCM4 (0)	VCM3 (0)	VCM2 (0)	VCM1 (0)	VCM0 (0)
R0Fh	Gate Scan Start Position	W	1	0	0	0	0	0	0	0	0	0	0	0	0	0	SCN4 (0)	SCN3 (0)	SCN2 (0)	SCN1 (0)	SCN0 (0)
R10h	CP/WM 18/16-bit Selection	W	1	0	0	0	0	0	0	0	0	0	0	0	0	0	0	0	0	F (0)	
R11h	Vertical Scroll Control	W	1	0	0	0	0	0	0	0	0	0	0	VL7 (0)	VL6 (0)	VL5 (0)	VL4 (0)	VL3 (0)	VL2 (0)	VL1 (0)	VL0 (0)
R14h	First Screen Driving Position	W	1	SE17 (1)	SE16 (0)	SE15 (0)	SE14 (1)	SE13 (1)	SE12 (1)	SE11 (1)	SE10 (1)	SS17 (0)	SS16 (0)	SS15 (0)	SS14 (0)	SS13 (0)	SS12 (0)	SS11 (0)	SS10 (0)		
R15h	Second Screen Driving Position	W	1	SE27 (1)	SE26 (0)	SE25 (0)	SE24 (1)	SE23 (1)	SE22 (1)	SE21 (1)	SE20 (1)	SS27 (0)	SS26 (0)	SS25 (0)	SS24 (0)	SS23 (0)	SS22 (0)	SS21 (0)	SS20 (0)		
R16h	Horizontal RAM Address Position	W	1	HEA7 (0)	HEA6 (0)	HEA5 (0)	HEA4 (1)	HEA3 (1)	HEA2 (1)	HEA1 (1)	HEA0 (1)	HSA7 (0)	HSA6 (0)	HSA5 (0)	HSA4 (0)	HSA3 (0)	HSA2 (0)	HSA1 (0)	HSA0 (0)		
R17h	Vertical RAM Address Position	W	1	VEA7 (0)	VEA6 (0)	VEA5 (0)	VEA4 (1)	VEA3 (1)	VEA2 (1)	VEA1 (1)	VEA0 (1)	VSA7 (0)	VSA6 (0)	VSA5 (0)	VSA4 (0)	VSA3 (0)	VSA2 (0)	VSA1 (0)	VSA0 (0)		
R20h	16-bits RAM Write Data Mask	W	1	WM15 (0)	WM14 (0)	WM13 (0)	WM12 (0)	WM11 (0)	WM10 (0)	WM9 (0)	WM8 (0)	WM7 (0)	WM6 (0)	WM5 (0)	WM4 (0)	WM3 (0)	WM2 (0)	WM1 (0)	WM0 (0)		
R21h	RAM Address Set	W	1	AD15 (0)	AD14 (0)	AD13 (0)	AD12 (0)	AD11 (0)	AD10 (0)	AD9 (0)	AD8 (0)	AD7 (0)	AD6 (0)	AD5 (0)	AD4 (0)	AD3 (0)	AD2 (0)	AD1 (0)	AD0 (0)		
R22h	RAM data Write/Read	R	1		RAM		WD17-0 /RAM		(RD17-0)												
R23h	18-bits RAM Write Data Mask (1)	W	1	0	0	WM11 (0)	WM10 (0)	WM9 (0)	WM8 (0)	WM7 (0)	WM6 (0)	0	0	WM5 (0)	WM4 (0)	WM3 (0)	WM2 (0)	WM1 (0)	WM0 (0)		
R24h	18-bits RAM Write Data Mask (2)	W	1	0	0	0	0	0	0	0	0	0	0	WM17 (0)	WM16 (0)	WM15 (0)	WM14 (0)	WM13 (0)	WM12 (0)		
R25h	18-bits Compare Register (1)	W	1	0	0	CP11 (0)	CP10 (0)	CP9 (0)	CP8 (0)	CP7 (0)	CP6 (0)	0	0	CP5 (0)	CP4 (0)	CP3 (0)	CP2 (0)	CP1 (0)	CP0 (0)		
R26h	18-bits Compare Register (2)	W	1	0	0	0	0	0	0	0	0	0	0	CP17 (0)	CP16 (0)	CP15 (0)	CP14 (0)	CP13 (0)	CP12 (0)		
R30h	r Control (1)	W	1	0	0	0	0	0	MP 12 (0)	MP 11 (0)	MP 10 (0)	0	0	0	0	0	MP 02 (0)	MP 01 (0)	MP 00 (0)		
R31h	r Control (2)	W	1	0	0	0	0	0	MP 32 (0)	MP P31 (0)	MP 30 (0)	0	0	0	0	0	MP 22 (0)	MP 21 (0)	MP 20 (0)		
R32h	r Control (3)	W	1	0	0	0	0	0	MP52 (0)	MP 51 (0)	MP 50 (0)	0	0	0	0	0	MP 42 (0)	MP 41 (0)	MP 40 (0)		
R33h	r Control (4)	W	1	0	0	0	0	0	CP 12 (0)	CP 11 (0)	CP 10 (0)	0	0	0	0	0	CP 02 (0)	CP 01 (0)	CP00 (0)		
R34h	r Control (5)	W	1	0	0	0	0	0	MN12 (0)	MN11 (0)	MN10 (0)	0	0	0	0	0	MN02 (0)	MN01 (0)	MN00 (0)		
R35h	r Control (6)	W	1	0	0	0	0	0	MN32 (0)	MN31 (0)	MN30 (0)	0	0	0	0	0	MN22 (0)	MN21 (0)	MN20 (0)		
R36h	r Control (7)	W	1	0	0	0	0	0	MN52 (0)	MN51 (0)	MN50 (0)	0	0	0	0	0	MN42 (0)	MN41 (0)	MN40 (0)		
R37h	r Control (8)	W	1	0	0	0	0	0	CN12 (0)	CN11 (0)	CN10 (0)	0	0	0	0	0	CN02 (0)	CN01 (0)	CN00 (0)		
R3Ah	r Control (9)	W	1	0	0	0	0	OP14 (0)	OP13 (0)	OP12 (0)	OP11 (0)	OP10 (0)	0	0	0	0	OP03 (0)	OP02 (0)	OP01 (0)	OP00 (0)	
R3Bh	r Control (10)	W	1	0	0	0	0	ON14 (0)	ON13 (0)	ON12 (0)	ON11 (0)	ON10 (0)	0	0	0	0	ON03 (0)	ON02 (0)	ON01 (0)	ON00 (0)	