

## 1A STEP DOWN SWITCHING REGULATOR

- UP TO 1A STEP DOWN CONVERTER
- OPERATING INPUT VOLTAGE FROM 8V TO 55V
- PRECISE 5.1V REFERENCE VOLTAGE
- OUTPUT VOLTAGE ADJUSTABLE FROM 3.3V TO 50V
- SWITCHING FREQUENCY ADJUSTABLE UP TO 500KHz
- VOLTAGE FEEDFORWARD
- ZERO LOAD CURRENT OPERATION
- INTERNAL CURRENT LIMITING (PULSE-BY-PULSE AND HICCUP MODE)
- PROTECTION AGAINST FEEDBACK DISCONNECTION
- THERMAL SHUTDOWN

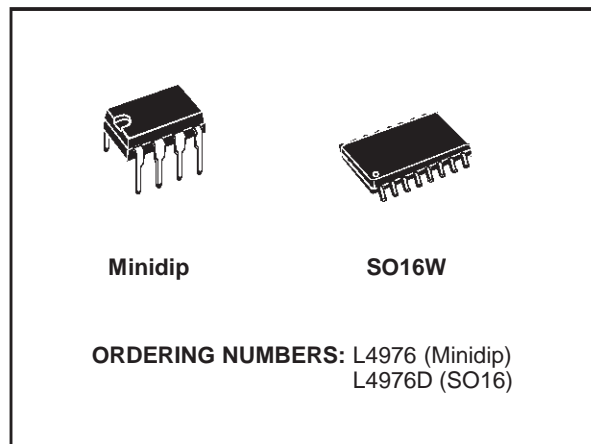

### DESCRIPTION

The L4976 is a step down monolithic power switching regulator delivering 1A at a voltage between 3.3V and 50V (selected by a simple external divider). Realized in BCD mixed technology, the device uses an internal power D-MOS transistor (with a typical  $R_{dson}$  of  $0.25\Omega$ ) to obtain very high efficiency and high switching speed. A switching frequency up to 250KHz is achievable (the maximum power dissipation of the pack-

ages must be observed).

A wide input voltage range between 8V to 55V and output voltages regulated from 3.3V to 40V cover the majority of today's applications.

Features of this new generations of DC-DC converter include pulse-by-pulse current limit, hiccup mode for short circuit protection, voltage feedforward regulation, protection against feedback loop disconnection and thermal shutdown.

The device is available in plastic dual in line, MINIDIP 8 for standard assembly, and SO16W for SMD assembly.

### TYPICAL APPLICATION CIRCUIT

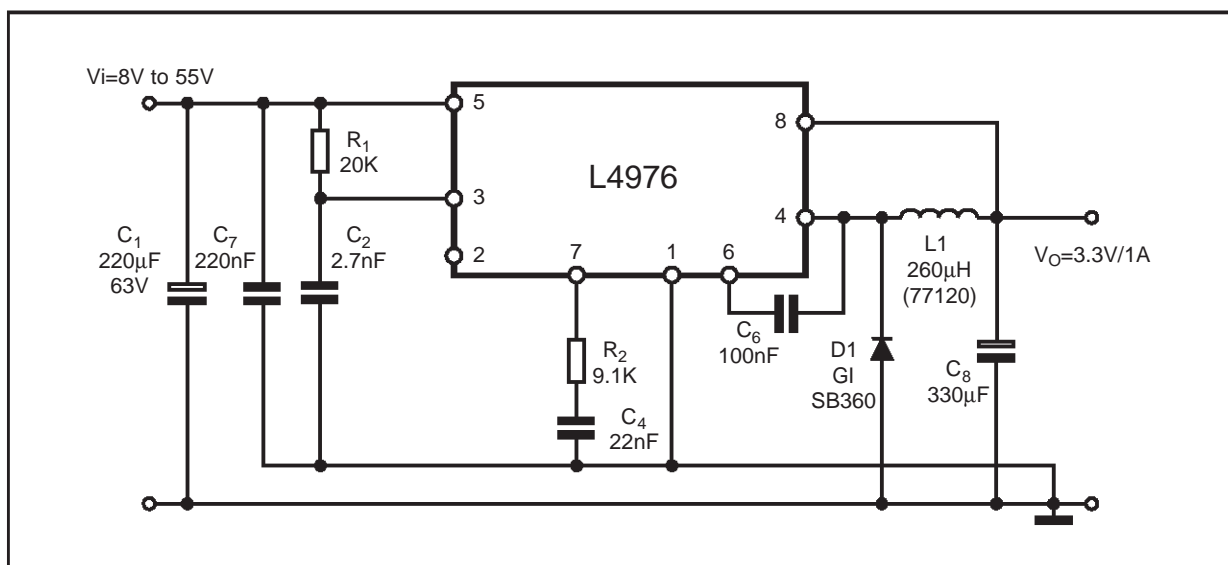

**BLOCK DIAGRAM**

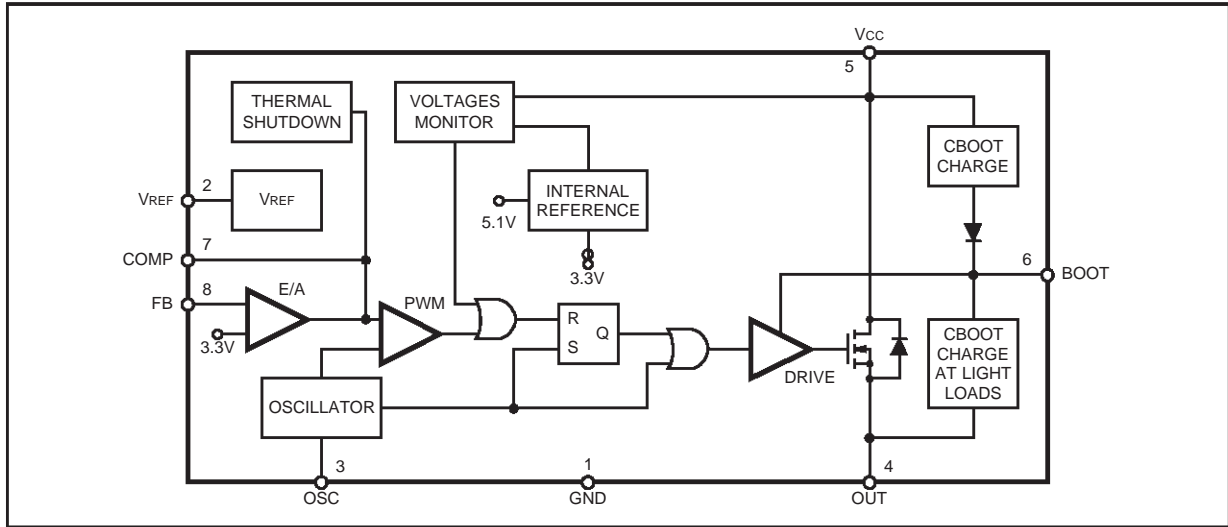

**PIN CONNECTIONS**

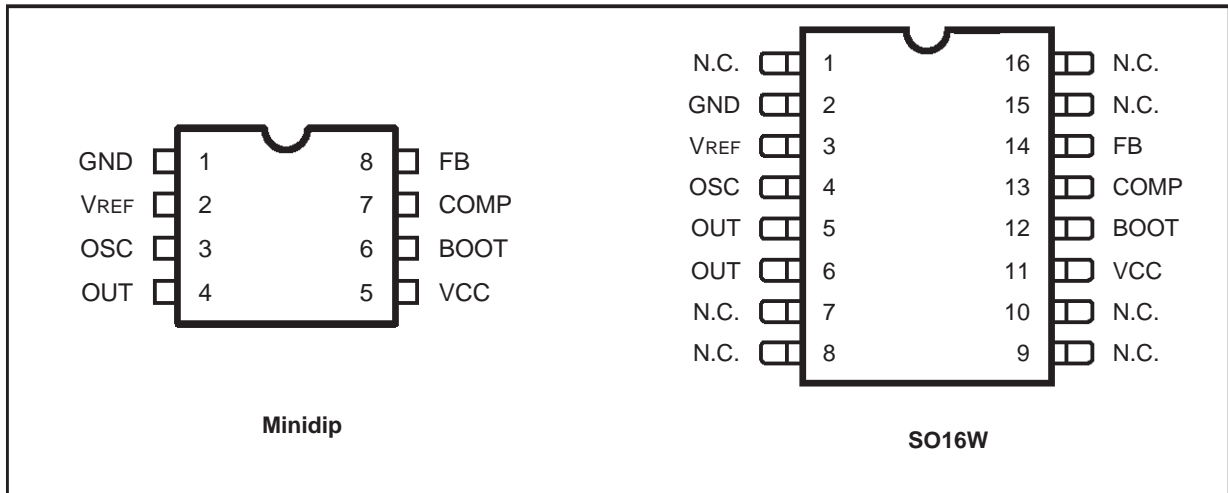

**PIN FUNCTIONS**

DIP	SO (*)	Name	Function
1	2	GND	Ground
2	3	VREF	5.1V Reference voltage with 20mA current capability.
3	4	OSC	An external resistor connected between the unregulated input voltage and this pin and a capacitor connected from this pin to ground fix the switching frequency. (Line feed forward is automatically obtained)
4	5, 6	OUT	Stepdown regulator output
5	11	Vcc	Unregulated DC input voltage
6	12	BOOT	A capacitor connected between this pin and OUT allows to drive the internal VDMOS
7	13	COMP	E/A output to be used for frequency compensation
8	14	FB	Stepdown feedback input. Connecting directly to this pin results in an output voltage of 3.3V. An external resistive divider is required for higher output voltages.

(\*) Pins 1, 7, 8, 9, 10, 15 and 16 are not connected.

## THERMAL DATA

Symbol	Parameter	Minidip	SO16	Unit
$R_{th(j-amb)}$	Thermal Resistance Junction to ambient	Max. 90 (*)	110 (*)	°C/W

(\*) Package mounted on board.

## OPERATING TEMPERATURE RATING

Symbol	Parameter	Value	Unit
$T_J$	Junction Temperature Range	-40 to 150	°C

## ABSOLUTE MAXIMUM RATINGS

Symbol		Parameter	Value	Unit	
Minidip	SO16				
$V_5$	$V_{11}$	Input voltage	58	V	
$V_4$	$V_5, V_6$	Output DC voltage	-1	V	
		Output peak voltage at $t = 0.1\mu s$ $f = 200KHz$	-5	V	
$I_4$	$I_5, I_6$	Maximum output current	int. limit.		
$V_6-V_5$	$V_{12}-V_{11}$		14	V	
$V_6$	$V_{12}$	Bootstrap voltage	70	V	
$V_7$	$V_{13}$	Analogs input voltage ( $V_{CC} = 24V$ )	12	V	
$V_8$	$V_{14}$	( $V_{CC} = 20V$ )	6 -0.3	V V	
$P_{tot}$		Power dissipation at $T_{amb} \leq 60^\circ C$	Minidip	1	W
			SO16	0.8	W
$T_j, T_{stg}$		Junction and storage temperature	-40 to 150	°C	

**ELECTRICAL CHARACTERISTICS** ( $T_j = 25^\circ C$ ,  $C_{osc} = 2.7nF$ ,  $R_{osc} = 20k\Omega$ ,  $V_{CC} = 24V$ , unless otherwise specified.) \* Specification Referred to  $T_j$  from 0 to  $125^\circ C$

Symbol	Parameter	Test Condition	Min.	Typ.	Max.	Unit	
<b>DYNAMIC CHARACTERISTIC</b>							
$V_i$	Operating input voltage range	$V_o = 3.3$ to $50V$ ; $I_o = 1A$	*	8	55	V	
$V_o$	Output voltage	$I_o = 0.5A$		3.33	3.36	3.39	V
		$I_o = 0.2$ to $1A$		3.292	3.36	3.427	V
		$V_{CC} = 8$ to $55V$	*	3.22	3.36	3.5	V
$V_d$	Dropout voltage	$V_{CC} = 10V$ ; $I_o = 1A$		0.44	0.55	V	
			*		0.88	V	
$I_i$	Maximum limiting current	$V_{CC} = 8$ to $55V$	*	1.5	2	2.5	A
	Efficiency	$V_o = 3.3V$ ; $I_o = 1A$		85		%	
$f_s$	Switching frequency		*	90	100	110	KHz
SVRR	Supply voltage ripple rejection	$V_i = V_{CC} + 2V_{RMS}$ ; $V_o = V_{ref}$ ; $I_o = 1A$ ; $f_{ripple} = 100Hz$		60			dB
	Voltage stability of switching frequency	$V_{CC} = 8$ to $55V$		3	6	%	
	Temp. stability of switching frequency	$T_j = 0$ to $125^\circ C$		4		%	

## ELECTRICAL CHARACTERISTICS (continued)

Symbol	Parameter	Test Condition	Min.	Typ.	Max.	Unit	
<b>Reference Section</b>							
	Reference Voltage		5.0	5.1	5.2	V	
		$I_{ref} = 0$ to 10mA; $V_{CC} = 8$ to 55V	*	4.950	5.1	5.250	V
	Line Regulation	$I_{ref} = 0$ mA; $V_{CC} = 8$ to 55V		5	10	mV	
	Load Regulation	$V_{ref} = 0$ to 5mA; $V_{CC} = 0$ to 20mA		2 6	10 25	mV mV	
	Short Circuit Current		30	65	100	mA	
<b>DC Characteristics</b>							
$I_{qop}$	Total operating quiescent current			4	6	mA	
$I_q$	Quiescent current	Duty Cycle = 0; $V_{FB} = 3.8$ V		2.5	3.5	mA	
<b>Error Amplifier</b>							
$V_{FB}$	Voltage Feedback Input		3.33	3.36	3.39	V	
$R_L$	Line regulation	$V_{CC} = 8$ to 55V		5	10	mV	
	Ref. voltage stability vs temperature		*	0.4		mV/°C	
$V_{oH}$	High level output voltage	$V_{FB} = 2.5$ V	10.3			V	
$V_{oL}$	Low level output voltage	$V_{FB} = 3.8$ V			0.65	V	
$I_{o\ source}$	Source output current	$V_{comp} = 6$ V; $V_{FB} = 2.5$ V	180	220		μA	
$I_{o\ sink}$	Sink output current	$V_{comp} = 6$ V; $V_{FB} = 3.8$ V	200	300		μA	
$I_b$	Source bias current			2	3	μA	
SVRR E/A	Supply voltage ripple rejection	$V_{comp} = V_{fb}$ ; $V_{CC} = 8$ to 55V	60	80		dB	
	DC open loop gain	$R_L = \infty$	50	57		dB	
gm	Transconductance	$I_{comp} = -0.1$ to 0.1mA $V_{comp} = 6$ V		2.5		ms	
<b>Oscillator Section</b>							
	Ramp Valley		0.78	0.85	0.92	V	
	Ramp peak	$V_{CC} = 8$ V	2	2.15	2.3	V	
		$V_{CC} = 55$ V	9	9.6	10.2	V	
	Maximum duty cycle		95	97		%	
	Maximum Frequency	Duty Cycle = 0% $R_{osc} = 13$ kΩ, $C_{osc} = 820$ pF			500	kHz	

**Figure 1. Quiescent drain current vs. input voltage.**

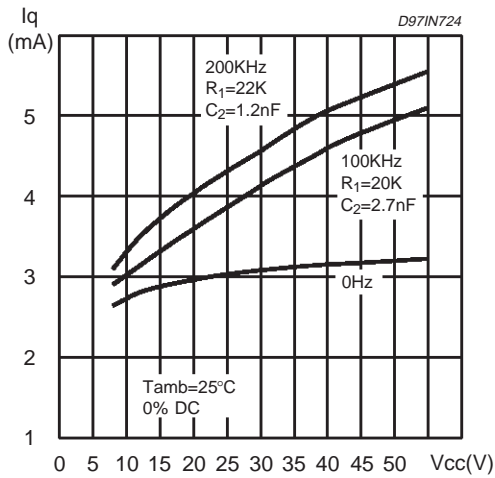

**Figure 2. Quiescent current vs. junction temperature**

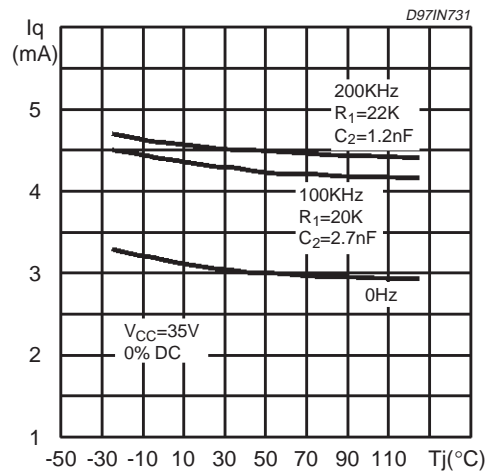

**Figure 3. Line Regulation**

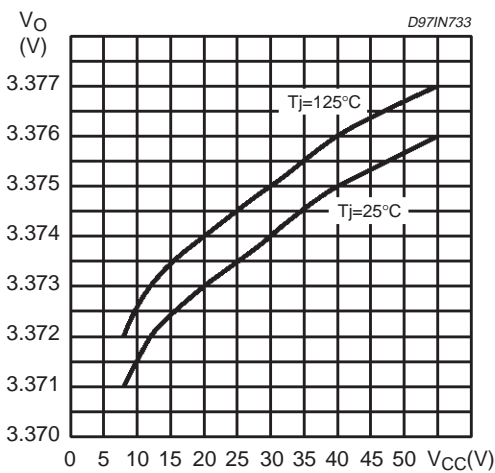

**Figure 4. Load regulation**

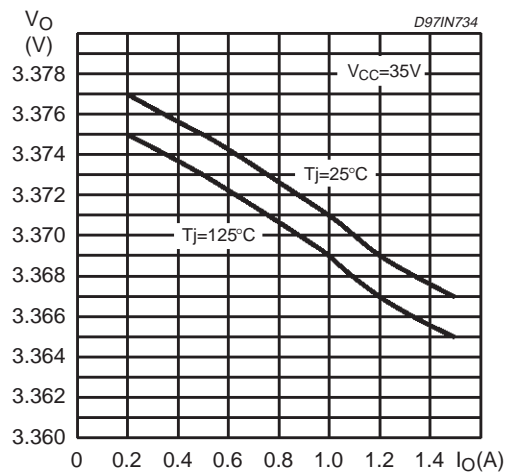

**Figure 5. Switching frequency vs. R1 and C2**

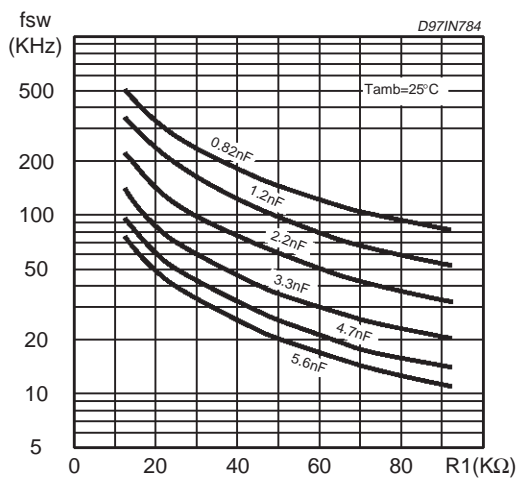

**Figure 6. Switching Frequency vs. input voltage.**

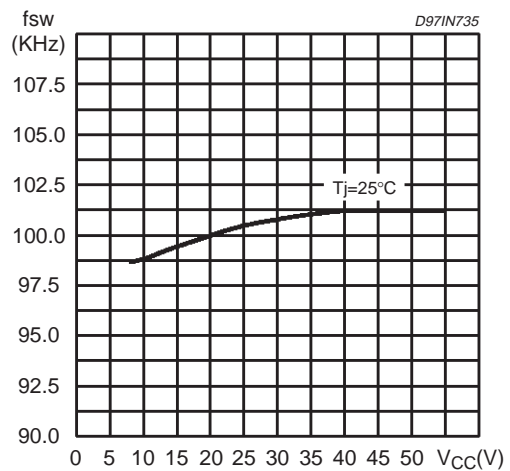

Figure 7. Switching frequency vs. junction temperature.

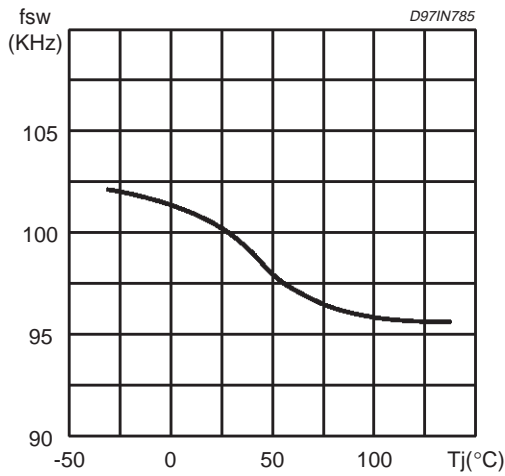

Figure 8. Dropout voltage between pin 5 and 4.

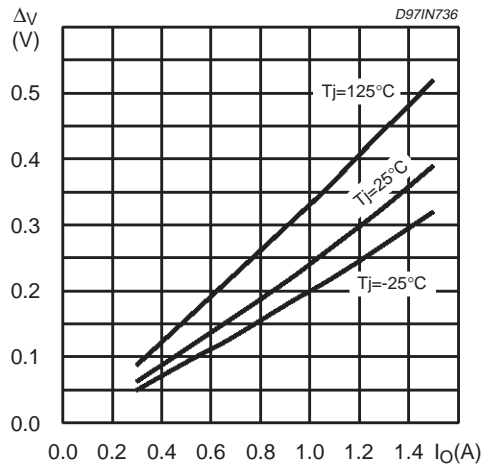

Figure 9. Efficiency vs output voltage.

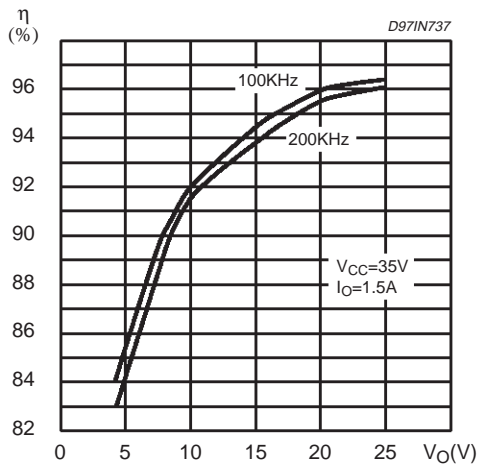

Figure 10. Efficiency vs. output current.

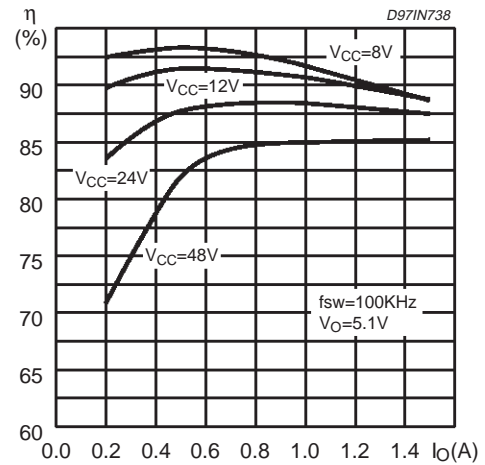

Figure 11. Efficiency vs. output current.

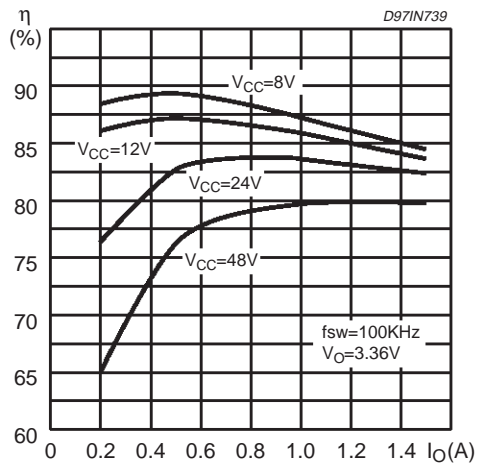

Figure 12. Efficiency vs. output current.

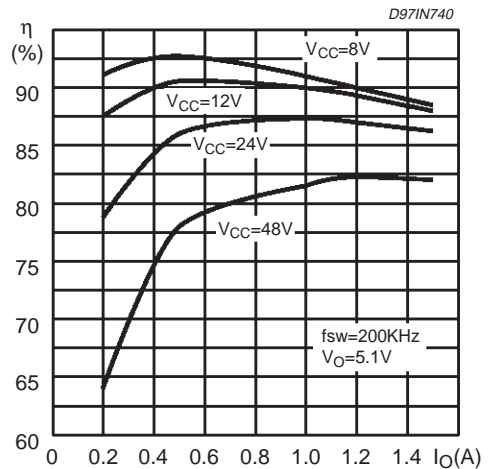

Figure 13. Efficiency vs. output current.

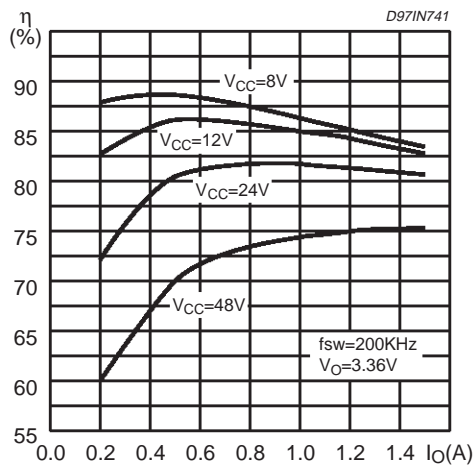

Figure 14. Efficiency vs. Vcc.

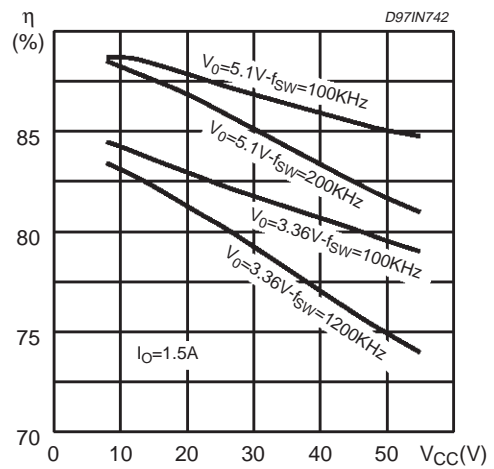

Figure 15. Power dissipation vs. Vcc.

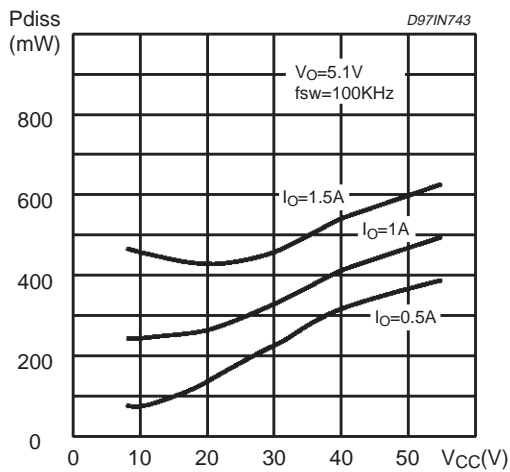

Figure 16. Efficiency vs. V\_o.

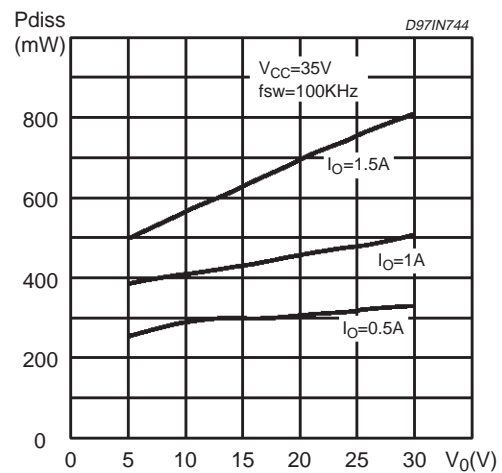

Figure 17. Pulse by pulse limiting current vs. junction temperature.

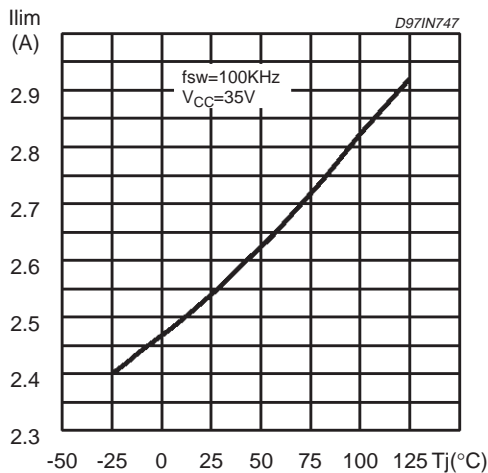

Figure 18. Load transient.

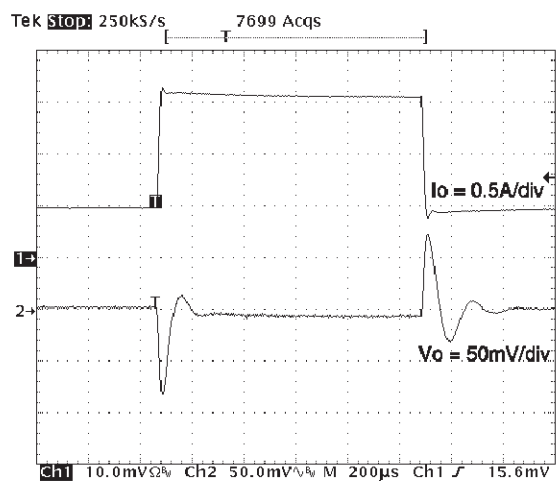

Figure 19. Line transient.

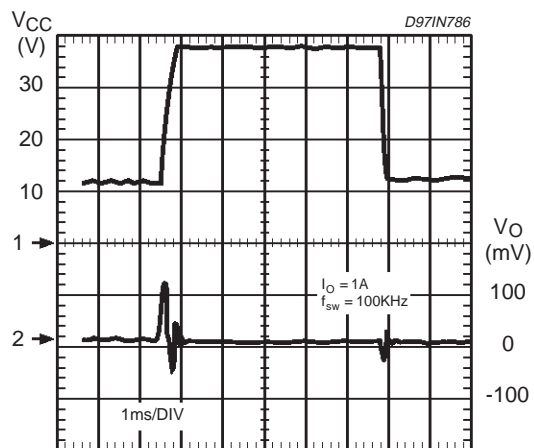
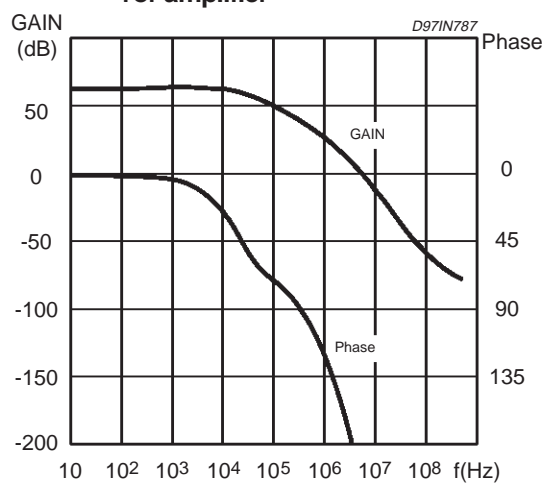

Figure 20. Open loop frequency and phase of error amplifier





DIM.	mm			inch		
	MIN.	TYP.	MAX.	MIN.	TYP.	MAX.
A		3.32			0.131	
a1	0.51			0.020		
B	1.15		1.65	0.045		0.065
b	0.356		0.55	0.014		0.022
b1	0.204		0.304	0.008		0.012
D			10.92			0.430
E	7.95		9.75	0.313		0.384
e		2.54			0.100	
e3		7.62			0.300	
e4		7.62			0.300	
F			6.6			0.260
I			5.08			0.200
L	3.18		3.81	0.125		0.150
Z			1.52			0.060

## OUTLINE AND MECHANICAL DATA

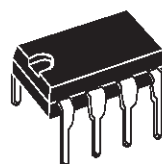

**Minidip**

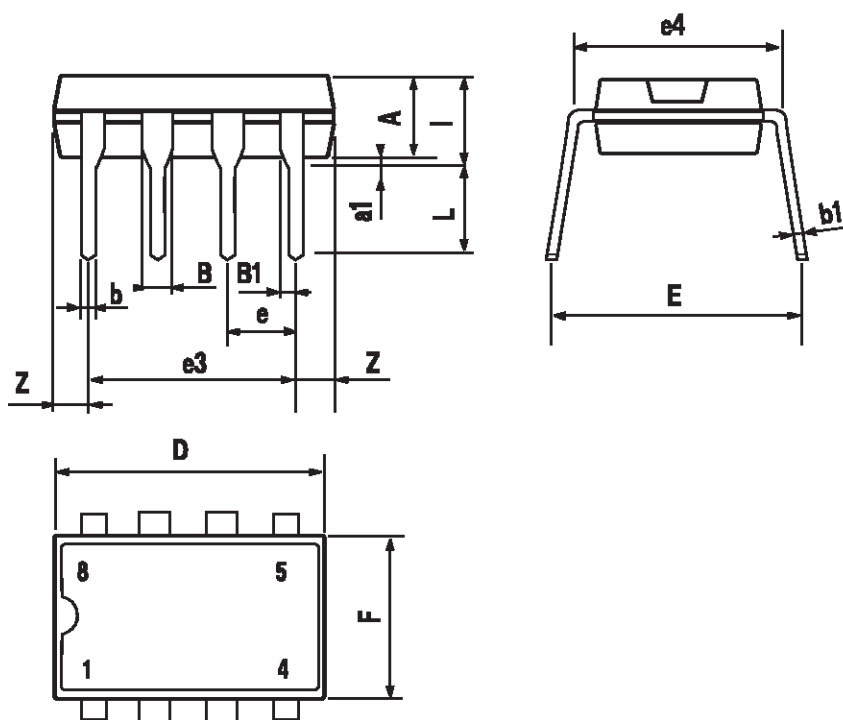

DIM.	mm			inch		
	MIN.	TYP.	MAX.	MIN.	TYP.	MAX.
A	2.35		2.65	0.093		0.104
A1	0.1		0.3	0.004		0.012
B	0.33		0.51	0.013		0.020
C	0.23		0.32	0.009		0.013
D	10.1		10.5	0.398		0.413
E	7.4		7.6	0.291		0.299
e		1.27			0.050	
H	10		10.65	0.394		0.419
h	0.25		0.75	0.010		0.030
L	0.4		1.27	0.016		0.050
K	0° (min.)8° (max.)					

**OUTLINE AND MECHANICAL DATA**

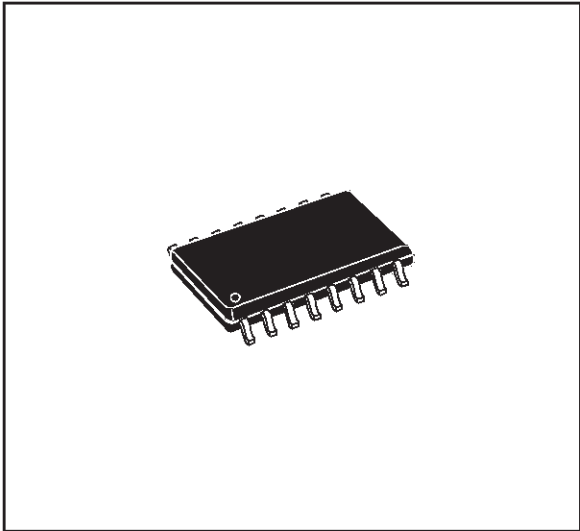

**SO16 Wide**

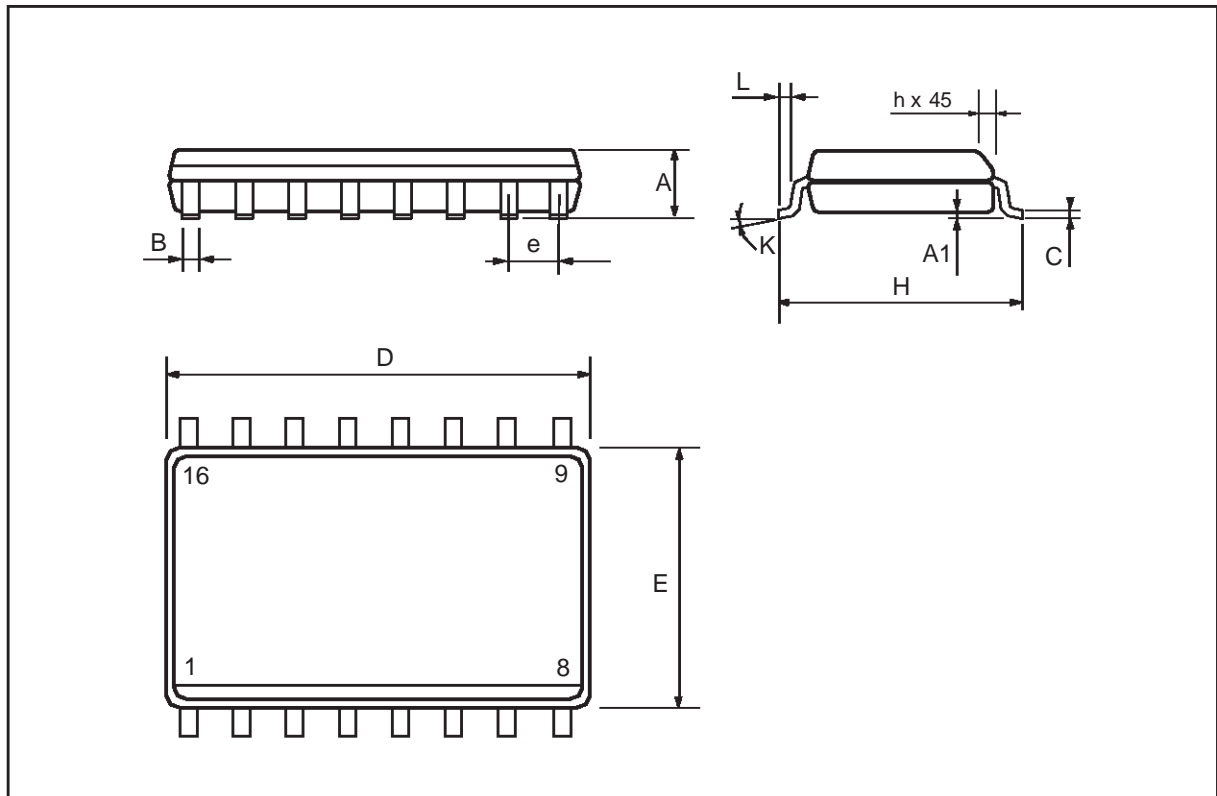

Information furnished is believed to be accurate and reliable. However, STMicroelectronics assumes no responsibility for the consequences of use of such information nor for any infringement of patents or other rights of third parties which may result from its use. No license is granted by implication or otherwise under any patent or patent rights of STMicroelectronics. Specification mentioned in this publication are subject to change without notice. This publication supersedes and replaces all information previously supplied. STMicroelectronics products are not authorized for use as critical components in life support devices or systems without express written approval of STMicroelectronics.

The ST logo is a registered trademark of STMicroelectronics

© 1999 STMicroelectronics – Printed in Italy – All Rights Reserved

STMicroelectronics GROUP OF COMPANIES

Australia - Brazil - Canada - China - France - Germany - Italy - Japan - Korea - Malaysia - Malta - Mexico - Morocco - The Netherlands - Singapore - Spain - Sweden - Switzerland - Taiwan - Thailand - United Kingdom - U.S.A.

<http://www.st.com>