



LA4450

Two Channel Power IC for Bus or Track Use in TV and Home Audio Applications

Overview

The LA4450 is a single package two channel power IC that supports an operating voltage of 26 V. It is particularly well suited for use as the bus or track power IC in car stereo applications. Additionally, since the LA4450 can drive 4 Ω loads, it can be used effectively in high-power high-end products. Furthermore, since it supports a high operating voltage and has low distortion, it is also optimal for use in TV and home audio products.

Functions

- Standby switch (active on high (+5 V) input)
- On-chip impulse noise protection circuit
- On-chip thermal protection circuit
- On-chip overvoltage and surge protection circuits

Features

- Two channels in a single package
- $P_O = 12\text{ W} \times 2$ ($V_{CC} = 26.4\text{ V}$, $R_L = 8\ \Omega$, THD = 10%)
- $P_O = 20\text{ W} \times 2$ ($V_{CC} = 26.4\text{ V}$, $R_L = 4\ \Omega$, THD = 10%)
- Can drive 4 Ω speakers
- Built-in standby switch
- Minimizes impulse noises

Specifications

Maximum Ratings at $T_a = 25^\circ\text{C}$

Parameter	Symbol	Conditions	Ratings	Unit
Maximum supply voltage	$V_{CC\text{ max}}$	$R_g = 0$ (no signal)	37	V
Maximum output current	$I_{O\text{ peak}}$		4	A
Allowable power dissipation	$P_{d\text{ max}^*}$	Infinite heat sink	25	W
Operating temperature	T_{opr}		-35 to +80	$^\circ\text{C}$
Storage temperature	T_{stg}		-40 to +150	$^\circ\text{C}$

Note: * Set V_{CC} and R_L within ranges that do not cause P_d max to exceed 25 W.
(When V_{CC} is 37 V, R_L should be 6 Ω or larger and when V_{CC} is 35 V, R_L should be 4 Ω or larger.)

Operating Conditions at $T_a = 25^\circ\text{C}$

Parameter	Symbol	Conditions	Ratings	Unit
Recommended supply voltage	V_{CC}		26.4	V
Recommended load resistance	R_L		8	Ω
Operating supply voltage range	V_{CCop}		10 to 30	V

Package Dimensions

unit: mm

3023A-SIP14H

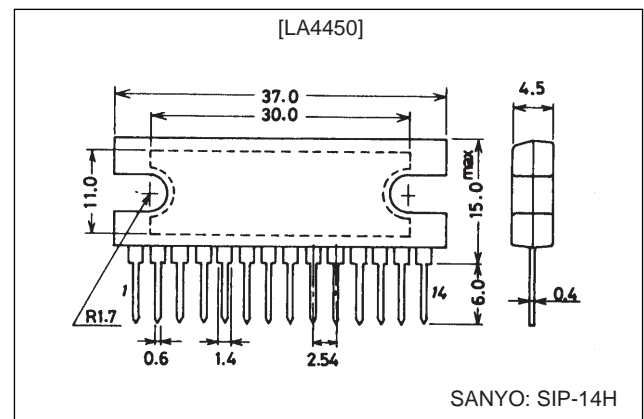

Operating Characteristics at $T_a = 25^\circ\text{C}$, $V_{CC} = 26.4\text{ V}$, $R_L = 8\ \Omega$, $f = 1\text{ kHz}$, $R_g = 600\ \Omega$

Parameter	Symbol	Conditions	Ratings			Unit
			min	typ	max	
Standby current	Ist	Standby switch off		1	30	μA
Quiescent current	I_{CCO}	$R_g = 0$	50	80	140	mA
Output power	P_{O1}	THD = 10%	10	12		W
	P_{O2}	THD = 10%, $R_L = 4\ \Omega$		20		W
Voltage gain	VG	$V_O = 0\text{ dBm}$	49	51	53	dB
Total harmonic distortion	THD	$P_O = 1\text{ W}$		0.07	0.4	%
Output noise voltage	V_{NO}	$R_g = 0$, BPF-BW = 20 Hz to 20 kHz		0.4	1.0	mV
Ripple exclusion ratio	SVRR	$R_g = 0$, $f_R = 100\text{ Hz}$, $V_R = 0\text{ dBm}$	45	55		dB
Channel separation	CHsep	$V_O = 0\text{ dBm}$, $R_g = 10\text{ k}\Omega$	45	55		dB
Standby control voltage	Vst	With a 10 k Ω resistor connected at pin 12	2.5		V_{CC}	V

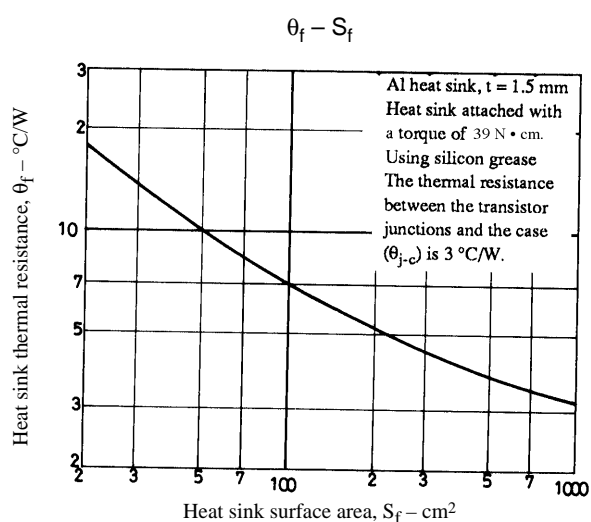
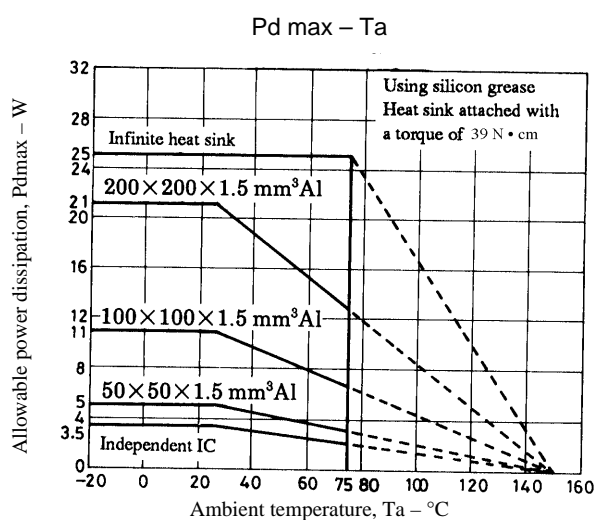

Test Circuit

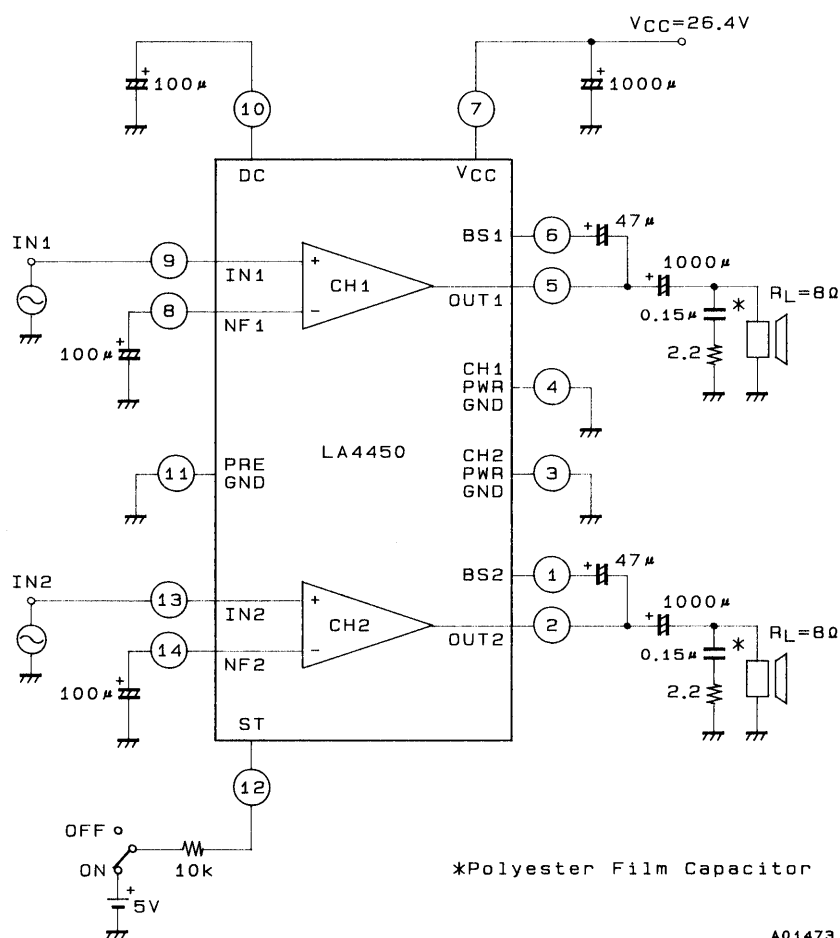

A01473

Unit (resistance : Ω, capacitance : F)

1. Features and Usage Notes

- Pin 12 is the standby pin. The IC operates when a voltage of 2 V or higher is applied through the external resistor R1. Note that the maximum influx current to pin 12 is 500 µA.
- Changing the voltage gain

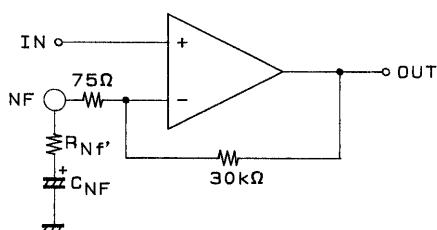

The voltage gain VG can be lowered by connecting an external resistor in series between the NF pin (pins 8 and 14) and C_{NF}.

$$VG = 20 \log \frac{30 \text{ k}\Omega}{75 + R_{NF'}}$$

However, since the IC may oscillate if VG is 30 dB or lower, use a VG of 36 dB or higher.

- The LA4450 includes a thermal protection circuit to prevent damage to or destruction of the IC due to abnormal overheating. As a result, the output may be attenuated or cut off if the application heat sinking is inadequate.
- The LA4450 includes an overvoltage protection circuit to protect the IC against power supply surges and abnormal voltages. This circuit has hysteresis characteristics: it operates at between 39 and 40 V, and recovers at around 34 V.
- Although the LA4450 includes a current limiter circuit to prevent damage due to abnormal currents, care must still be exercised to prevent load shorts and other excessive current conditions.

Sample Application Circuit

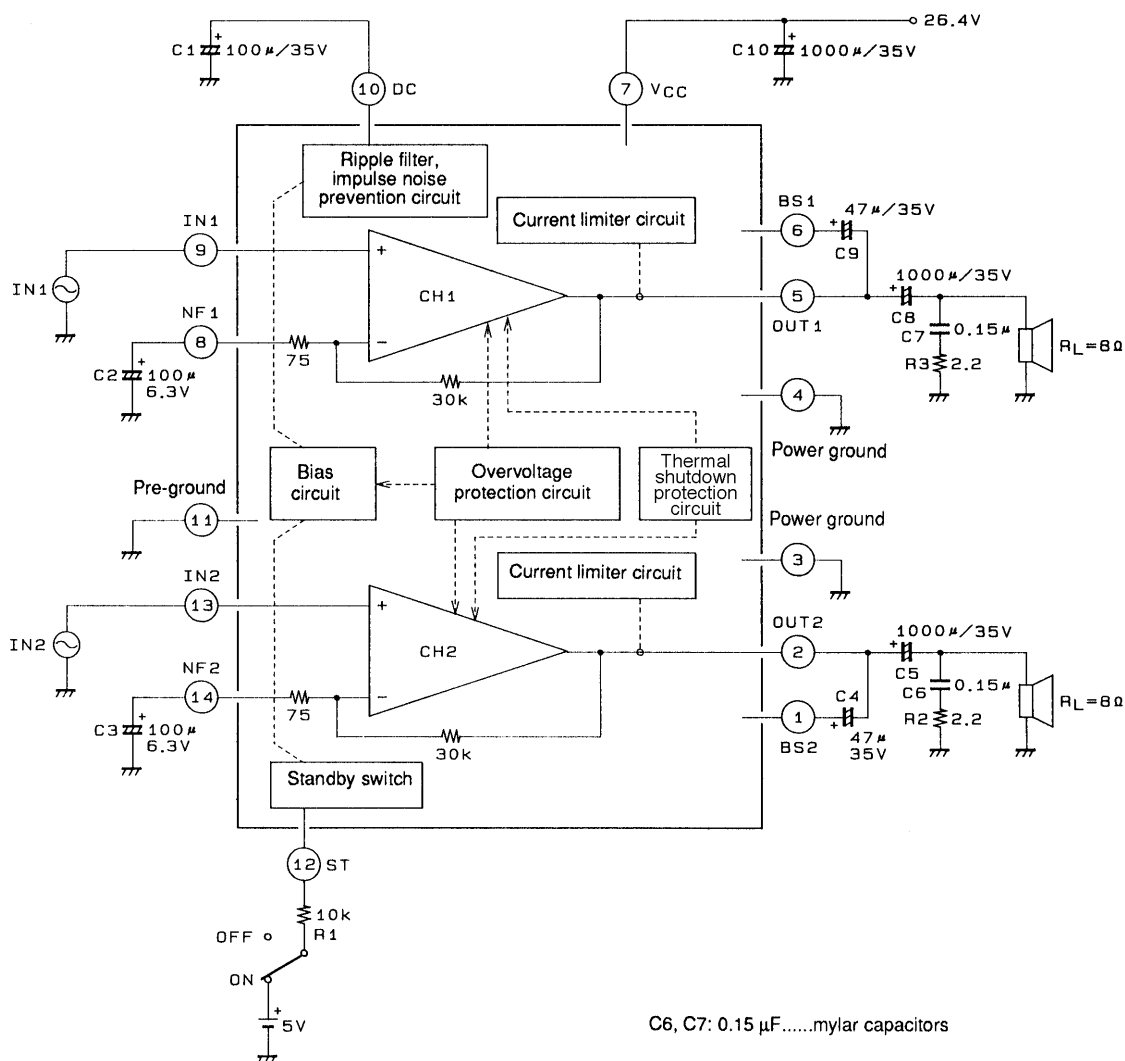

C6, C7: 0.15 µF.....mylar capacitors

A01474

Unit (resistance : Ω, capacitance : F)

Printed Circuit Board Pattern Example

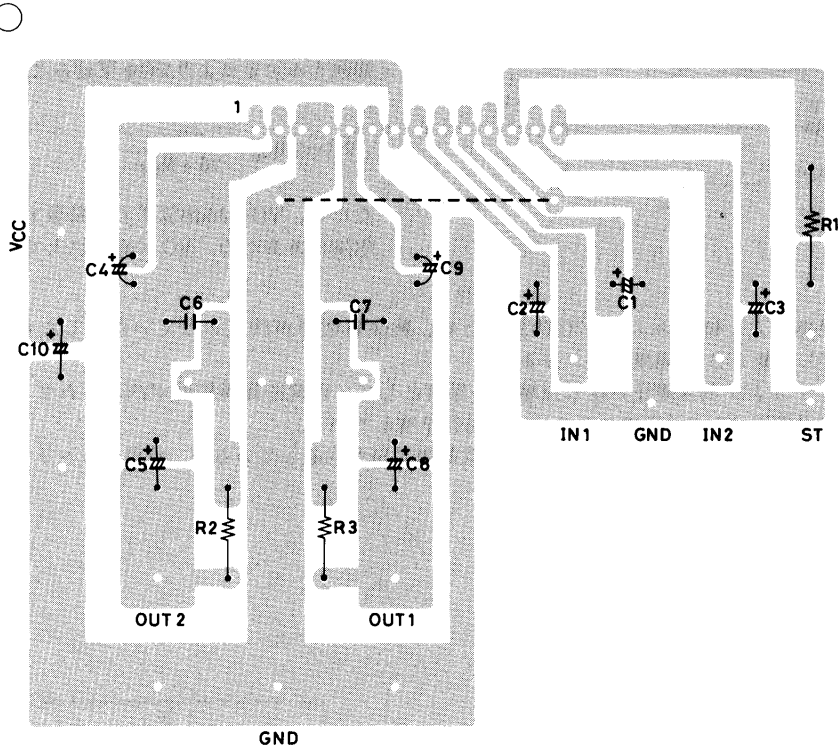

C opper foiled side
90 × 100 mm²

$P_O - V_{CC}$

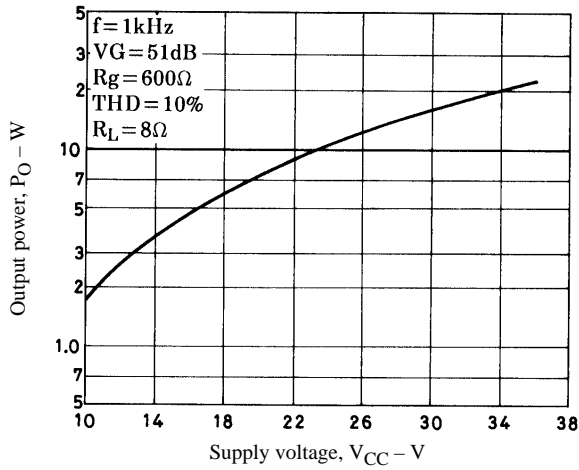

$P_O - V_{CC}$

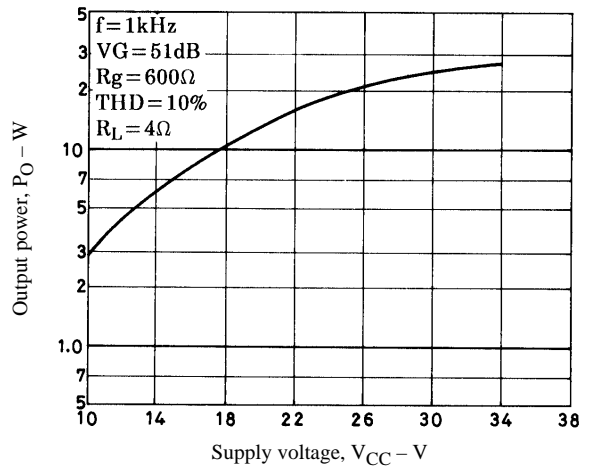

THD - P_O

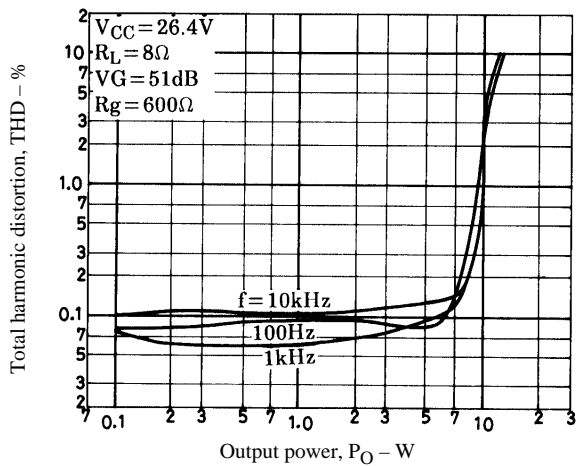

THD - P_O

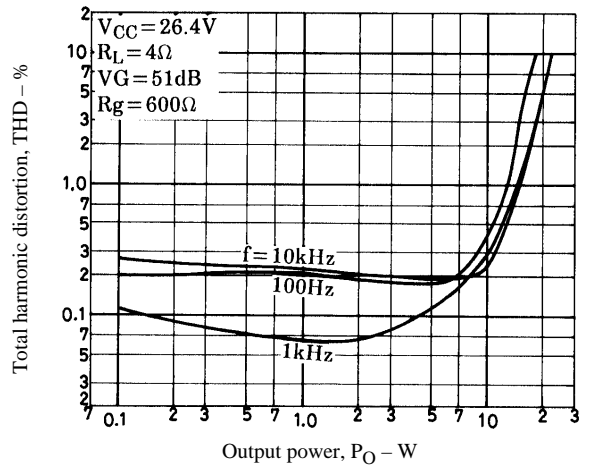

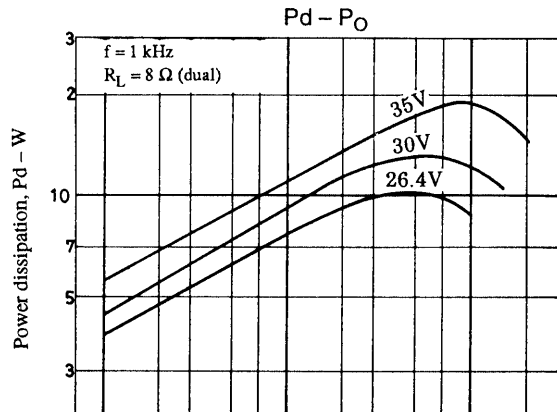
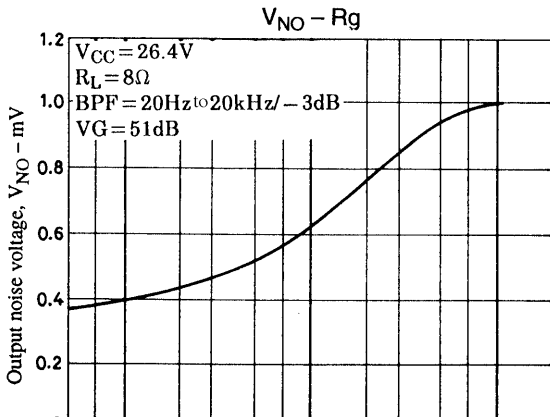
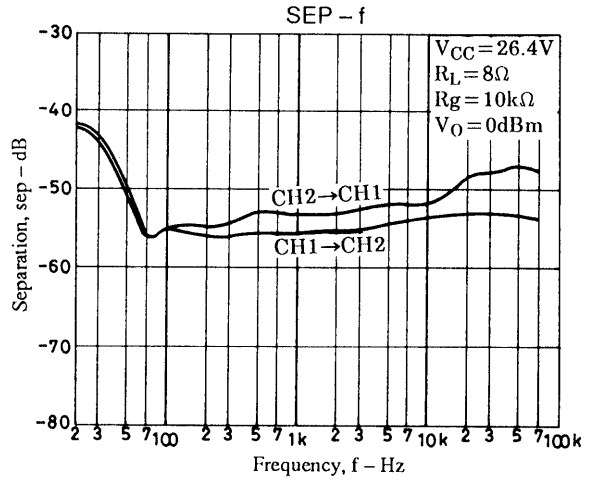
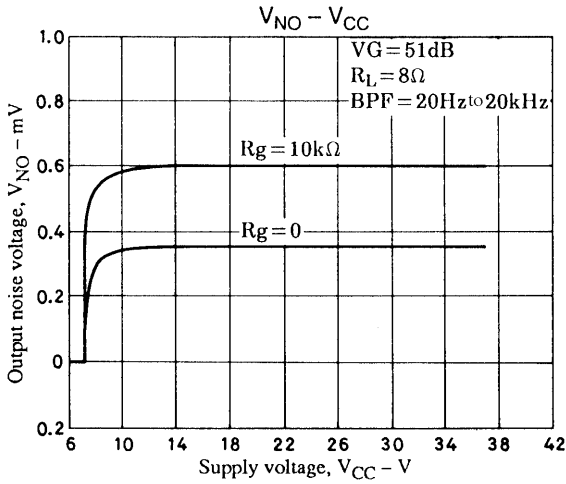
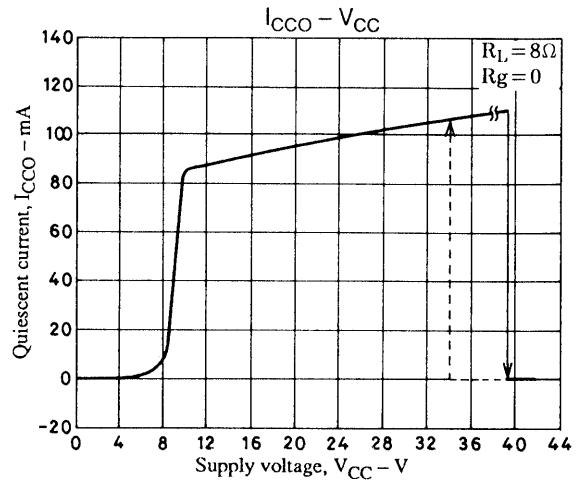
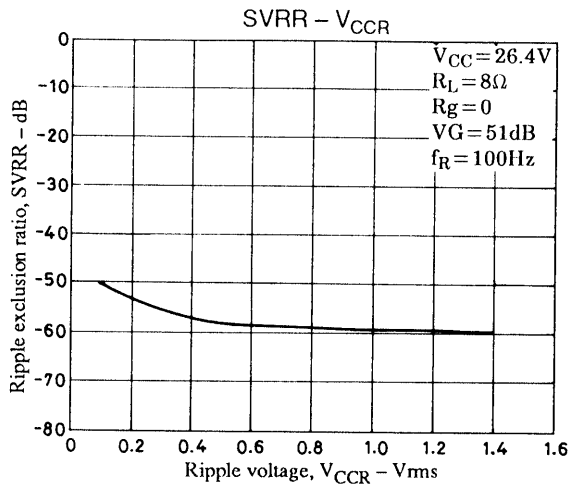
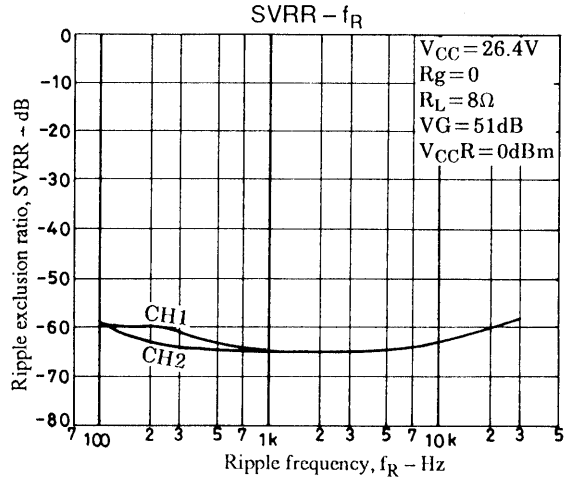
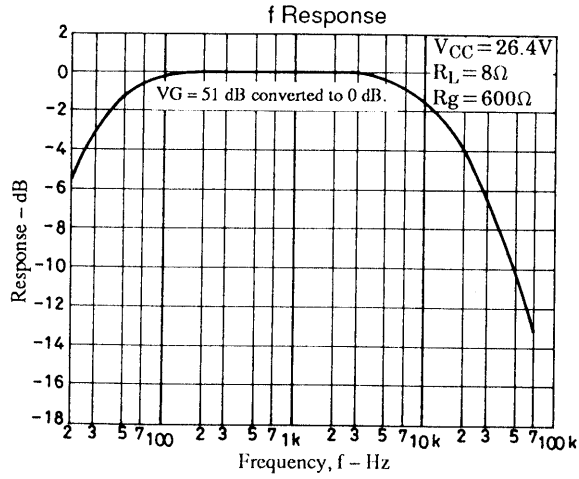

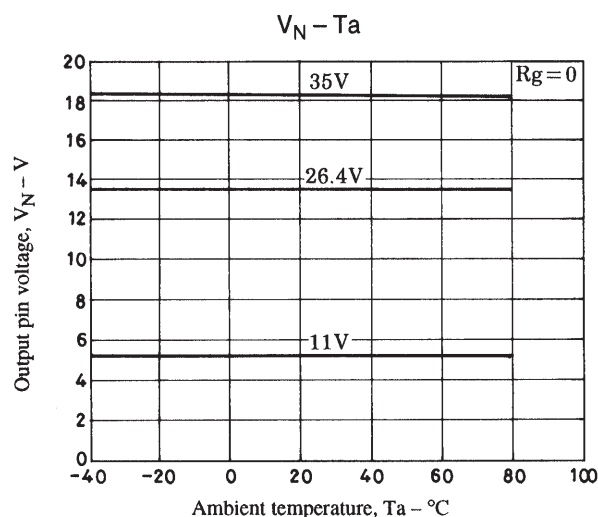
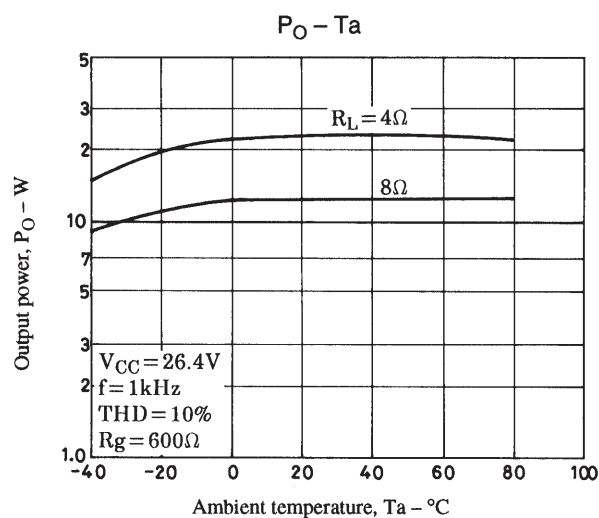
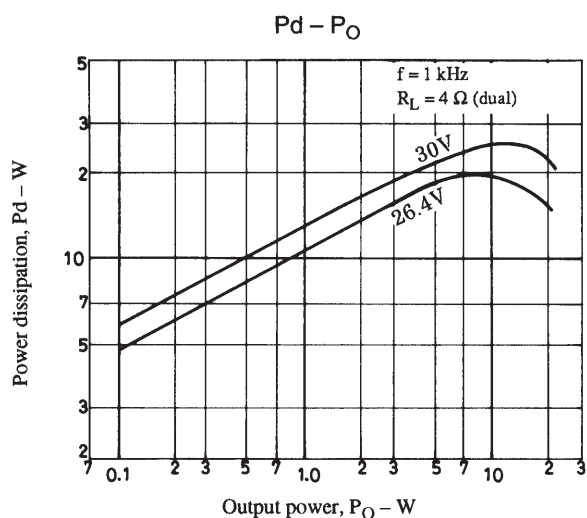

- No products described or contained herein are intended for use in surgical implants, life-support systems, aerospace equipment, nuclear power control systems, vehicles, disaster/crime-prevention equipment and the like, the failure of which may directly or indirectly cause injury, death or property loss.
- Anyone purchasing any products described or contained herein for an above-mentioned use shall:
 - ① Accept full responsibility and indemnify and defend SANYO ELECTRIC CO., LTD., its affiliates, subsidiaries and distributors and all their officers and employees, jointly and severally, against any and all claims and litigation and all damages, cost and expenses associated with such use:
 - ② Not impose any responsibility for any fault or negligence which may be cited in any such claim or litigation on SANYO ELECTRIC CO., LTD., its affiliates, subsidiaries and distributors or any of their officers and employees jointly or severally.
- Information (including circuit diagrams and circuit parameters) herein is for example only; it is not guaranteed for volume production. SANYO believes information herein is accurate and reliable, but no guarantees are made or implied regarding its use or any infringements of intellectual property rights or other rights of third parties.

This catalog provides information as of April, 1998. Specifications and information herein are subject to change without notice.