

**Ultra-Low Noise,  
 Low Distortion, Audio Op Amp**
**FEATURES**

- Voltage Noise 1.2nV/√Hz Max at 1kHz  
0.9nV/√Hz Typ at 1kHz
- Voltage and Current Noise 100% Tested
- Gain-Bandwidth Product 40MHz Min
- Slew Rate 10V/μs Min
- Voltage Gain 2 Million Min
- Low THD @ 10kHz,  $A_V = -10$ ,  $R_L = 600\Omega$ ,  $V_O = 7V_{RMS}$  0.002%
- Low IMD, CCIF Method,  $A_V = +10$ ,  $R_L = 600\Omega$ ,  $V_O = 7V_{RMS}$  0.0002%

**DESCRIPTION**

The LT1115 is the lowest noise audio operational amplifier available. This ultra-low noise performance (0.9nV/√Hz @ 1kHz) is combined with high slew rates (> 15V/μs) and very low distortion specifications.

The RIAA circuit shown below using the LT1115 has very low distortion and little deviation from ideal RIAA response (see graph).

**APPLICATIONS**

- High Quality Audio Preamplifiers
- Low Noise Microphone Preamplifiers
- Very Low Noise Instrumentation Amplifiers
- Low Noise Frequency Synthesizers
- Infrared Detector Amplifiers
- Hydrophone Amplifiers
- Low Distortion Oscillators

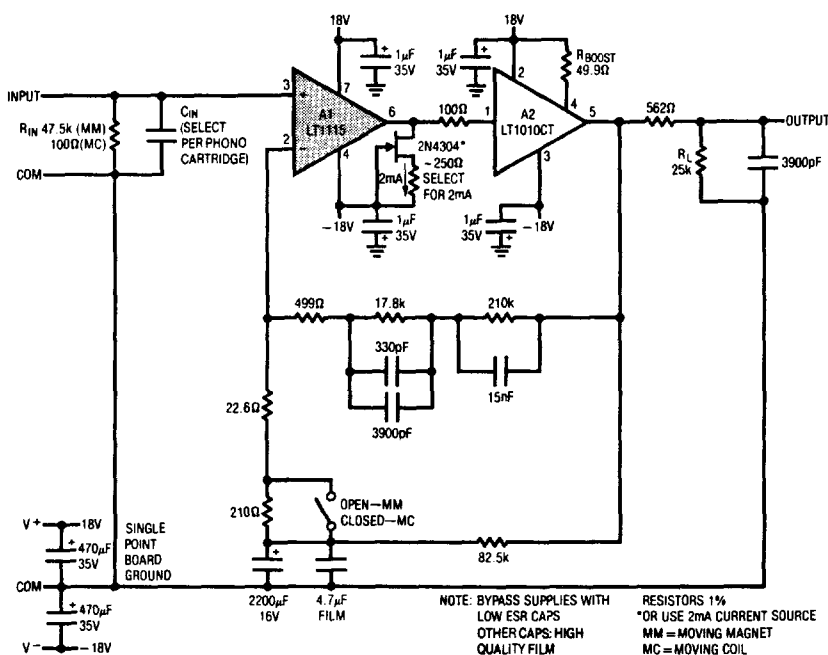
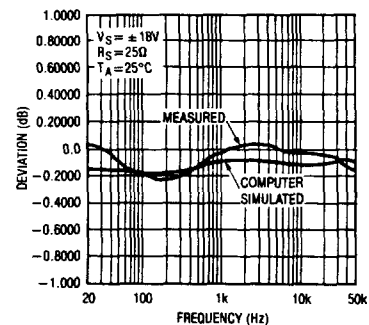
**TYPICAL APPLICATION**
**RIAA Phonograph Preamplifier (40/60db Gain)**

**Measured Deviation from RIAA  
 Response. Input @ 1kHz = 1mV<sub>RMS</sub>  
 Pre-Emphasized.**

## ABSOLUTE MAXIMUM RATINGS

Supply Voltage	± 22V
Differential Input Current (Note 4)	± 25mA
Input Voltage	Equal to Supply Voltage
Output Short Circuit Duration	Indefinite
Operating Temperature Range	0°C to 70°C
Storage Temperature Range	- 65°C to 150°C
Lead Temperature (Soldering, 10 sec.)	300°C

## PACKAGE/ORDER INFORMATION

<p>N PACKAGE 8-LEAD PLASTIC DIP</p>	ORDER PART NUMBER
	LT1115CN8
<p>S PACKAGE 16-LEAD PLASTIC SOL</p>	LT1115CS

2

## ELECTRICAL CHARACTERISTICS $V_S = \pm 18V, T_A = 25^\circ C$ , unless otherwise noted.

SYMBOL	PARAMETER	CONDITIONS	LT1115C			UNITS
			MIN	TYP	MAX	
THD	Total Harmonic Distortion @ 10kHz	$A_V = -10, V_O = 7V_{RMS}, R_L = 600$		< 0.002		%
IMD	Inter-Modulation Distortion (CCIF)	$A_V = 10, V_O = 7V_{RMS}, R_L = 600$		< 0.0002		%
$V_{OS}$	Input Offset Voltage	(Note 1)		50	200	$\mu V$
$I_{OS}$	Input Offset Current	$V_{CM} = 0V$		30	200	nA
$I_B$	Input Bias Current	$V_{CM} = 0V$		± 50	± 380	nA
$e_n$	Input Noise Voltage Density	$f_o = 10Hz$		1.0		$nV/\sqrt{Hz}$
		$f_o = 1000Hz, 100\% \text{ tested}$		0.9	1.2	$nV/\sqrt{Hz}$
	Wideband Noise	DC to 20kHz		120		$nV_{RMS}$
	Corresponding Voltage Level re 0.775V			- 136		dB
$i_n$	Input Noise Current Density (Note 2)	$f_o = 10Hz$		4.7		$pA/\sqrt{Hz}$
		$f_o = 1000Hz, 100\% \text{ tested}$		1.2	2.2	$pA/\sqrt{Hz}$
	Input Resistance			250		M $\Omega$
	Common-Mode			15		k $\Omega$
	Differential Mode					
	Input Capacitance			5		pF
	Input Voltage Range		± 13.5	± 15.0		V
CMRR	Common-Mode Rejection Ratio	$V_{CM} = \pm 13.5V$	104	123		dB
PSRR	Power Supply Rejection Ratio	$V_S = \pm 4V \text{ to } \pm 19V$	104	126		dB
$A_{VOL}$	Large Signal Voltage Gain	$R_L \geq 2k\Omega, V_O = \pm 14.5V$	2.0	20		$V/\mu V$
		$R_L \geq 1k\Omega, V_O = \pm 13V$	1.5	15		$V/\mu V$
		$R_L \geq 600\Omega, V_O = \pm 10V$	1.0	10		$V/\mu V$
$V_{OUT}$	Maximum Output Voltage Swing	No Load	± 15.5	± 16.5		V
		$R_L \geq 2k\Omega$	± 14.5	± 15.5		V
		$R_L \geq 600\Omega$	± 11.0	± 14.5		V
SR	Slew Rate	$A_{VOL} = -1$	10	15		$V/\mu s$
GBW	Gain-Bandwidth Product	$f_o = 20kHz$ (Note 3)	40	70		MHz
$Z_o$	Open Loop Output Impedance	$V_O = 0, I_O = 0$		70		$\Omega$
$I_S$	Supply Current			8.5	11.5	mA

**ELECTRICAL CHARACTERISTICS**  $V_S = \pm 18V, 0^\circ C \leq T_A \leq 70^\circ C$ , unless otherwise noted.

SYMBOL	PARAMETER	CONDITIONS	LT1115C			UNITS
			MIN	TYP	MAX	
$V_{OS}$	Input Offset Voltage	(Note 1)	●	75	280	$\mu V$
$\Delta V_{OS}/\Delta T$	Average Input Offset Drift			0.5		$\mu V/^\circ C$
$I_{OS}$	Input Offset Current	$V_{CM} = 0V$	●	40	300	nA
$I_B$	Input Bias Current	$V_{CM} = 0V$	●	$\pm 70$	$\pm 550$	nA
	Input Voltage Range		●	$\pm 13$	$\pm 14.8$	V
CMRR	Common-Mode Rejection Ratio	$V_{CM} = \pm 13V$	●	100	120	dB
PSRR	Power Supply Rejection Ratio	$V_S = \pm 4.5V$ to $\pm 18V$	●	100	123	dB
$A_{VOL}$	Large Signal Voltage Gain	$R_L \geq 2k\Omega, V_o = \pm 13V$ $R_L \geq 1k\Omega, V_o = \pm 11V$	●	1.5 1.0	15 10	$V/\mu V$ $V/\mu V$
$V_{OUT}$	Maximum Output Voltage Swing	No Load $R_L \geq 2k\Omega$ $R_L \geq 600\Omega$	●	$\pm 15$ $\pm 13.8$ $\pm 10$	$\pm 16.3$ $\pm 15.3$ $\pm 14.3$	V V V
$I_S$	Supply Current		●	9.3	13	mA

The ● denotes the specifications which apply over the full operating temperature range.

**Note 1:** Input Offset Voltage measurements are performed by automatic test equipment approximately 0.5 sec. after application of power.

**Note 2:** Current noise is defined and measured with balanced source resistors. The resultant voltage noise (after subtracting the resistor noise on an RMS basis) is divided by the sum of the two source resistors to obtain current noise.

**Note 3:** Gain-bandwidth product is not tested. It is guaranteed by design and by inference from the slew rate measurement.

**Note 4:** The inputs are protected by back-to-back diodes. Current limiting resistors are not used in order to achieve low noise. If differential input voltage exceeds  $\pm 1.8V$ , the input current should be limited to 25mA.

**TYPICAL PERFORMANCE CHARACTERISTICS**

Wideband Noise, DC to 20kHz

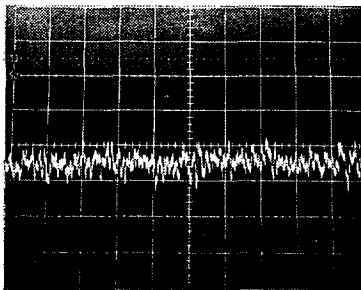

VERTICAL SCALE =  $0.5\mu V/DIV$   
HORIZONTAL SCALE =  $0.5ms/DIV$

Wideband Voltage Noise (0.1Hz to Frequency Indicated)

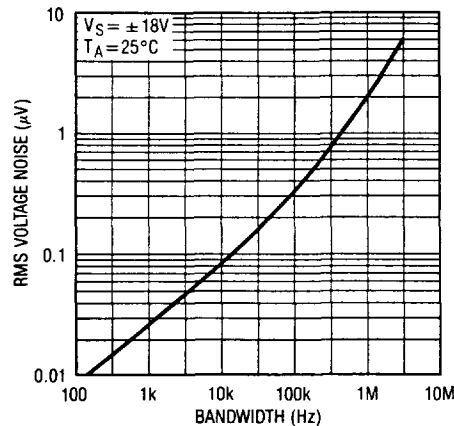

Total Noise vs Matched Source Resistance

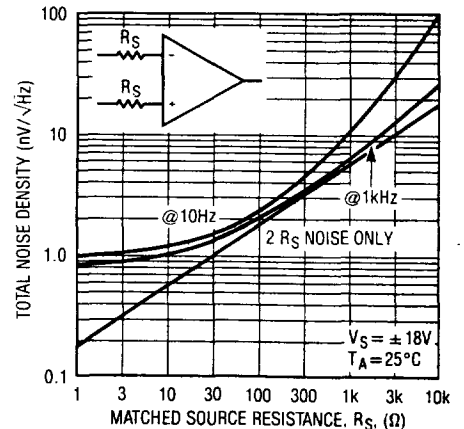

# TYPICAL PERFORMANCE CHARACTERISTICS

2

**THD + Noise vs Frequency**  
( $A_V = -10$ )

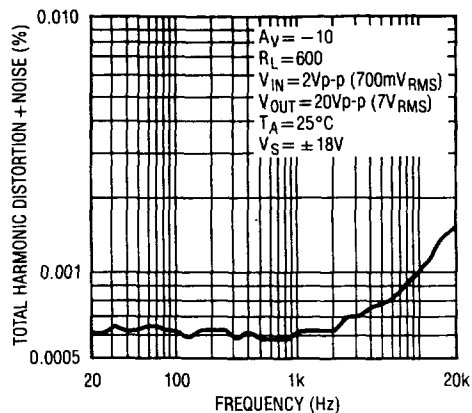

**THD + Noise vs Frequency**  
( $A_V = -100$ )

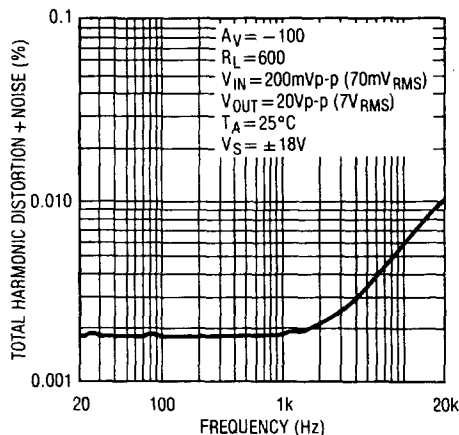

**THD + Noise vs Frequency**  
( $A_V = -1000$ )

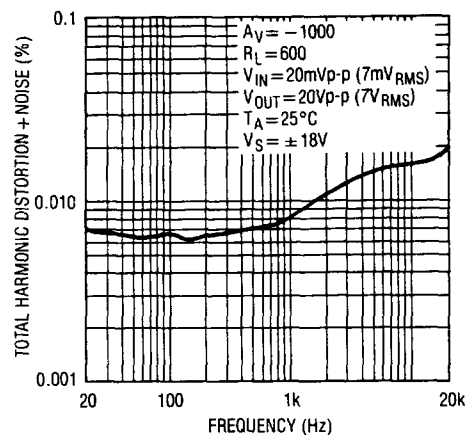

**THD + Noise vs Frequency**  
( $A_V = +10$ )

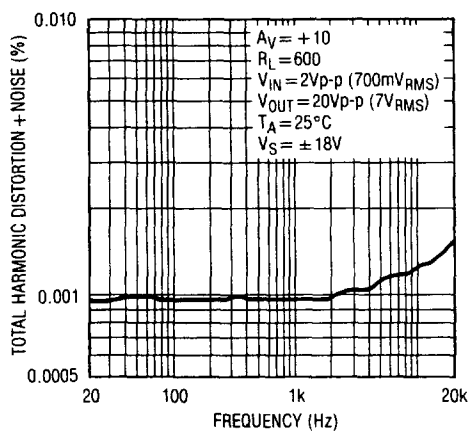

**THD + Noise vs Frequency**  
( $A_V = +100$ )

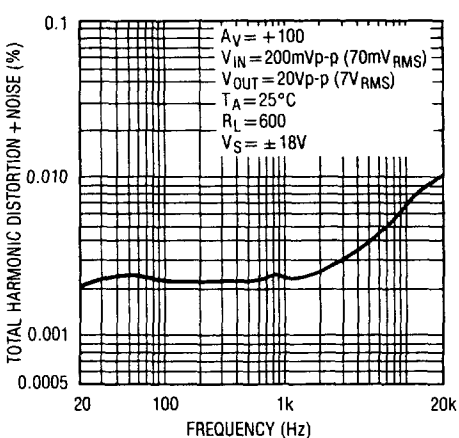

**THD + Noise vs Frequency**  
( $A_V = +1000$ )

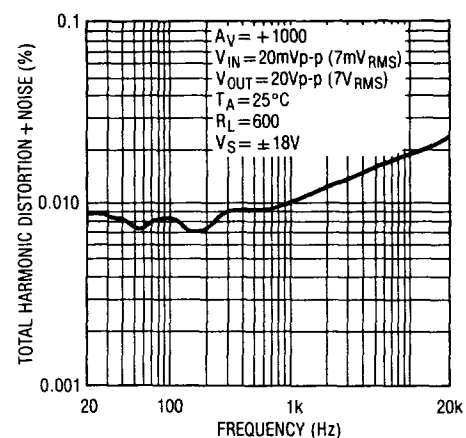

**CCIF IMD Test (Twin Equal Amplitude Tones at 13 and 14kHz)\***

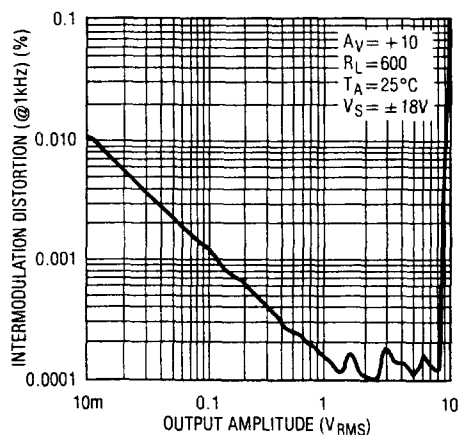

**CCIF IMD Test (Twin Equal Amplitude Tones at 13 and 14kHz)\***

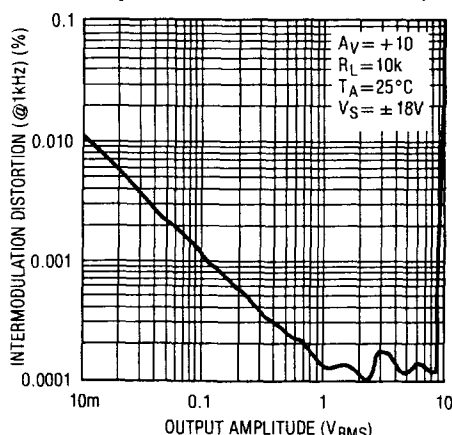

**Slew Rate, Gain-Bandwidth-Product vs Over-Compensation Capacitor**

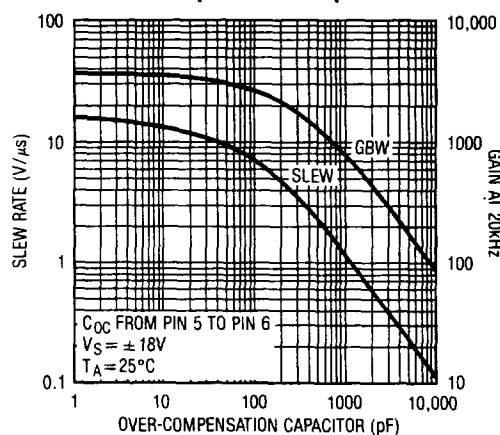

\*See CCIF Test Note at end of "Typical Performance Characteristics."

# TYPICAL PERFORMANCE CHARACTERISTICS

**Total Noise vs Unmatched Source Resistance**

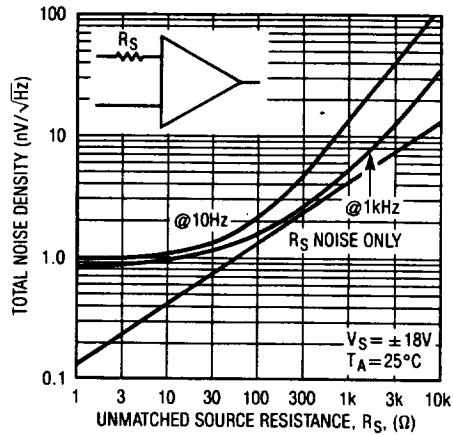

**Current Noise Spectrum**

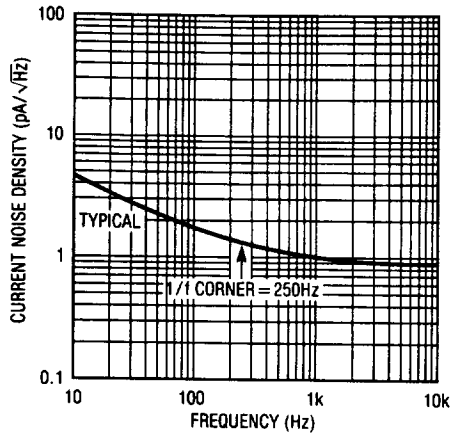

**Voltage Noise vs Temperature**

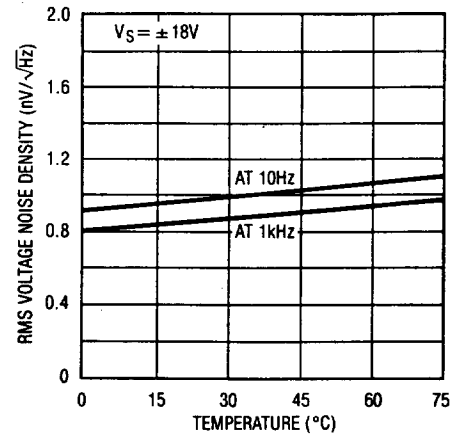

**Voltage Noise vs Supply Voltage**

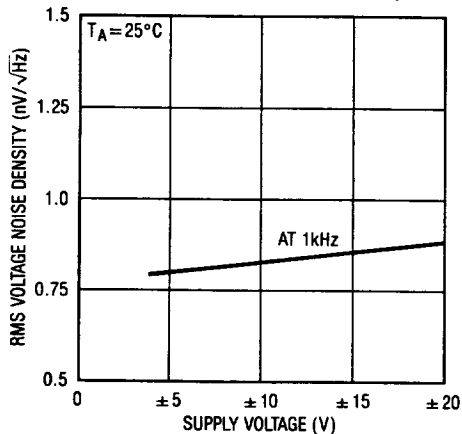

**Supply Current vs Temperature**

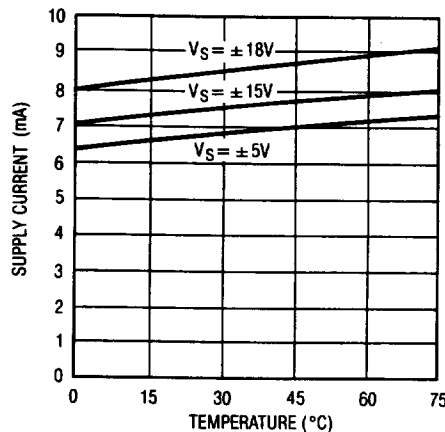

**Output Short Circuit Current vs Time**

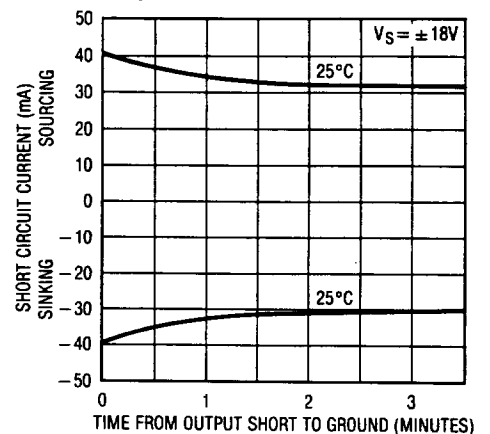

**Voltage Gain vs Frequency**

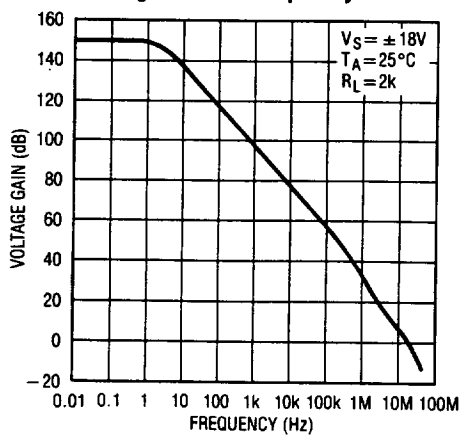

**Gain, Phase vs Frequency**

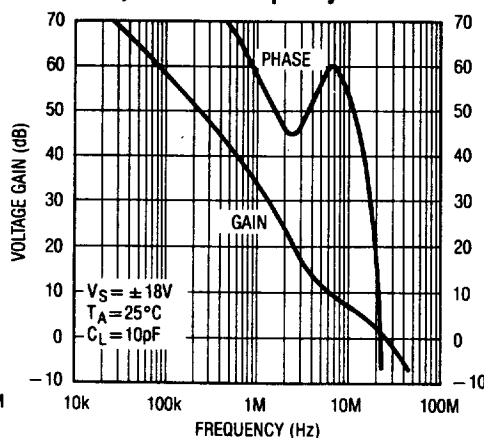

**Voltage Gain vs Supply Voltage**

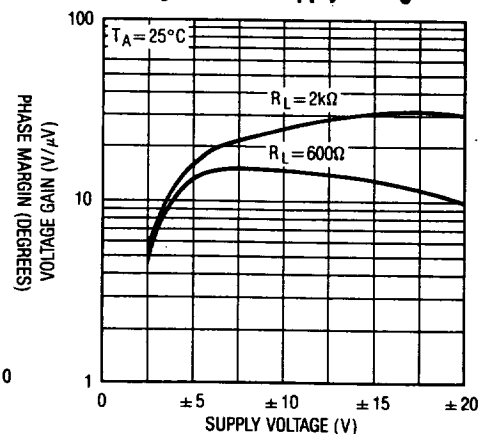

# TYPICAL PERFORMANCE CHARACTERISTICS

**Voltage Gain vs Load Resistance**

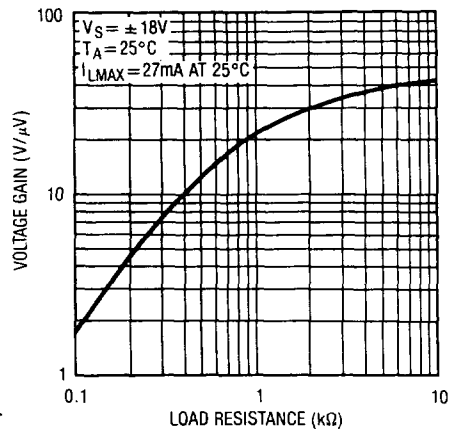

**Capacitance Load Handling**

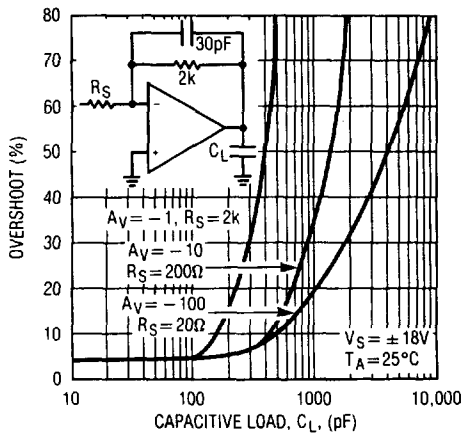

**Common-Mode Limit Over Temperature**

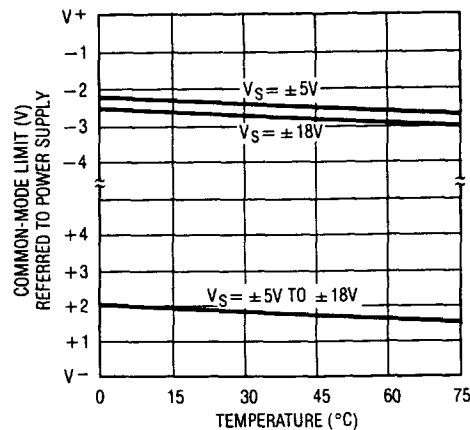

**Common-Mode Rejection Ratio vs Frequency**

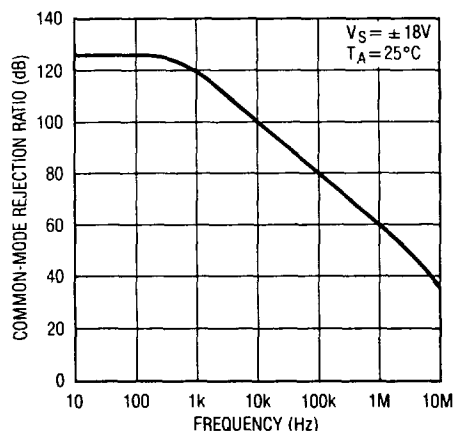

**Power Supply Rejection Ratio vs Frequency**

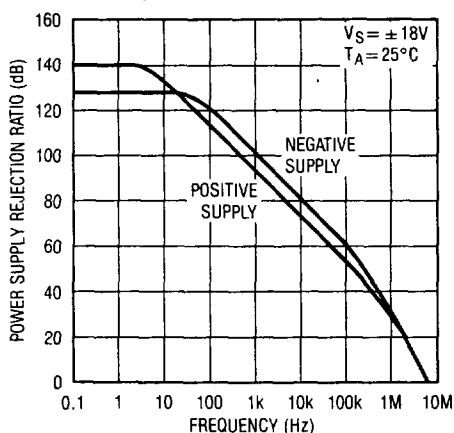

**Large Signal Transient Response**

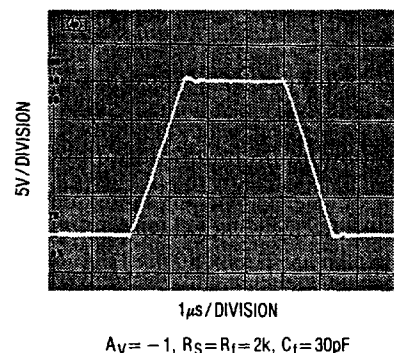

**Small Signal Transient Response**

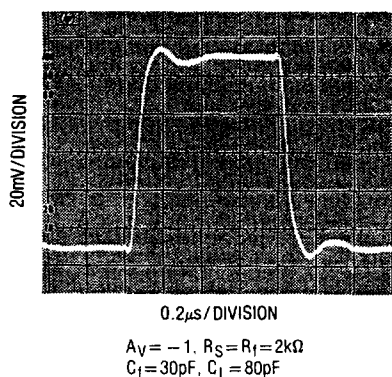

**Maximum Output vs Frequency (Power Bandwidth\*)**

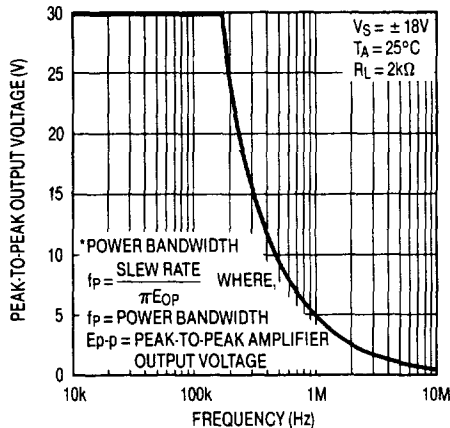

**Closed Loop Output Impedance**

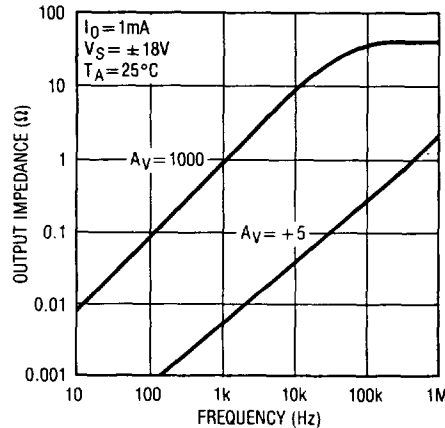

## TYPICAL PERFORMANCE CHARACTERISTICS

### CCIF Testing

**Note:** The CCIF twin-tone intermodulation test inputs two closely spaced equal amplitude tones to the device under test (DUT). The analyzer then measures the intermodulation distortion (IMD) produced in the DUT by measuring the difference tone equal to the spacing between the tones.

The amplitude of the IMD test input is in sinewave peak equivalent terms. As an example, selecting an amplitude of 1.000V will result in the complex IMD signal having the same 2.828V peak-to-peak amplitude that a 1.000V sinewave has. Clipping in a DUT will thus occur at the same input amplitude for THD + N and IMD modes.

## APPLICATIONS INFORMATION — NOISE

### Voltage Noise vs Current Noise

The LT1115's less than  $1\text{nV}/\sqrt{\text{Hz}}$  voltage noise matches that of the LT1028 and is three times better than the lowest voltage noise heretofore available (on the LT1007/1037). A necessary condition for such low voltage noise is operating the input transistors at nearly 1mA of collector currents, because voltage noise is inversely proportional to the square root of the collector current. Current noise, however, is directly proportional to the square root of the collector current. Consequently, the LT1115's current noise is significantly higher than on most monolithic op amps.

Therefore, to realize truly low noise performance it is important to understand the interaction between voltage noise ( $e_n$ ), current noise ( $i_n$ ) and resistor noise ( $r_n$ ).

### Total Noise vs Source Resistance

The total input referred noise of an op amp is given by

$$e_t = [e_n^2 + r_n^2 + (i_n R_{eq})^2]^{1/2}$$

where  $R_{eq}$  is the total equivalent source resistance at the two inputs

and  $r_n = \sqrt{4kTR_{eq}} = 0.13\sqrt{R_{eq}}$  in  $\text{nV}/\sqrt{\text{Hz}}$  at  $25^\circ\text{C}$

As a numerical example, consider the total noise at 1kHz of the gain of 1000 amplifier shown below.

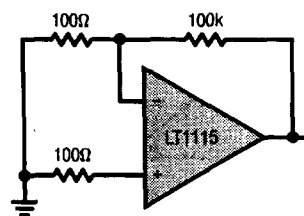

$$R_{eq} = 100\Omega + 100\Omega \parallel 100k \approx 200\Omega$$

$$r_n = 0.13\sqrt{200} = 1.84\text{nV}/\sqrt{\text{Hz}}$$

$$e_n = 0.85\text{nV}/\sqrt{\text{Hz}}$$

$$i_n = 1.0\text{pA}/\sqrt{\text{Hz}}$$

$$e_t = [0.85^2 + 1.84^2 + (1.0 \times 0.2)^2]^{1/2} = 2.04\text{nV}/\sqrt{\text{Hz}}$$

$$\text{output noise} = 1000 e_t = 2.04\mu\text{V}/\sqrt{\text{Hz}}$$

At very low source resistance ( $R_{eq} < 40\Omega$ ) voltage noise dominates. As  $R_{eq}$  is increased resistor noise becomes the largest term—as in the example above—and the LT1115's voltage noise becomes negligible. As  $R_{eq}$  is further increased, current noise becomes important. At 1kHz, when  $R_{eq}$  is in excess of  $20k\Omega$ , the current noise component is larger than the resistor noise. The total noise versus matched source resistance plot illustrates the above calculations.

## APPLICATIONS INFORMATION — NOISE

The plot also shows that current noise is more dominant at low frequencies, such as 10Hz. This is because resistor noise is flat with frequency, while the 1/f corner of current noise is typically at 250Hz. At 10Hz when  $R_{eq} > 1k\Omega$ , the current noise term will exceed the resistor noise.

When the source resistance is unmatched, the total noise versus unmatched source resistance plot should be consulted. Note that total noise is lower at source resistances below  $1k\Omega$  because the resistor noise contribution is less. When  $R_S > 1k\Omega$  total noise is not improved, however. This is because bias current cancellation is used to reduce input bias current. The cancellation circuitry injects two correlated current noise components into the two inputs. With matched source resistors the injected current noise creates a common-mode voltage noise and gets rejected by the amplifier. With source resistance in one input only, the cancellation noise is added to the amplifier's inherent noise.

In summary, the LT1115 is the optimum amplifier for noise performance—provided that the source resistance is kept low. The following table depicts which op amp manufactured by Linear Technology should be used to minimize noise—as the source resistance is increased beyond the LT1115's level of usefulness.

**Best Op Amp for Lowest Total Noise vs Source Resistance**

SOURCE RESISTANCE (Note 1)	BEST OP AMP	
	AT LOW FREQ (10Hz)	WIDEBAND (1kHz)
0 to 400 $\Omega$	LT1028/1115	LT1028/1115
400 $\Omega$ to 4k $\Omega$	LT1007/1037	LT1028/1115
4k $\Omega$ to 40k $\Omega$	LT1001*	LT1007/1037
40k $\Omega$ to 500k $\Omega$	LT1012*	LT1001*
500k $\Omega$ to 5M $\Omega$	LT1012* or LT1055	LT1012*
>5M	LT1055	LT1055

Note 1: Source resistance is defined as matched or unmatched, e.g.,  $R_S = 1k\Omega$  means:  $1k\Omega$  at each input, or  $1k\Omega$  at one input and zero at the other.

\* These op amps are best utilized in applications requiring less bandwidth than audio.

2

## APPLICATIONS INFORMATION — GENERAL

The LT1115 is a very high performance op amp, but not necessarily one which is optimized for universal application. Because of very low voltage noise and the resulting high gain-bandwidth product, the device is most applicable to relatively high gain applications. Thus, while the LT1115 will provide notably superior performance to the 5534 in most applications, the device may require circuit modifications to be used at very low noise gains.

The part is not generally applicable for unity gain followers or inverters. In general, it should always be used with good low impedance bypass capacitors on the supplies, low impedance feedback values, and minimal capacitive loading. Ground plane construction is recommended, as is a compact layout.

## TYPICAL APPLICATIONS

Figure 1. Balanced Transformerless Microphone Preamp

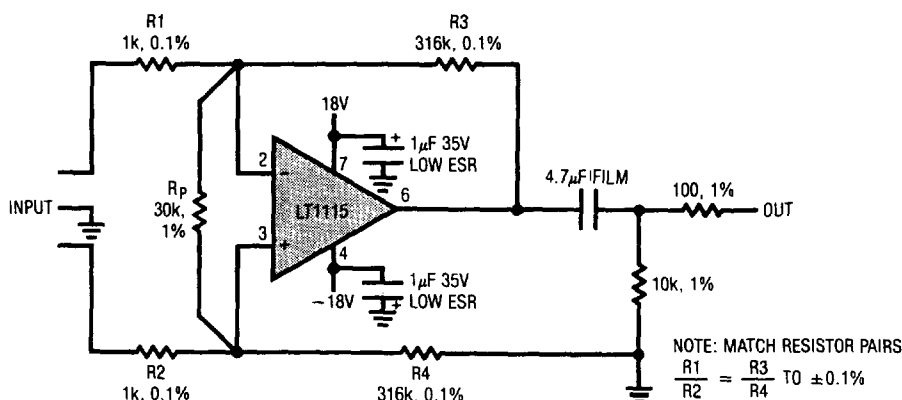

THD + Noise vs Frequency (Figure 1)

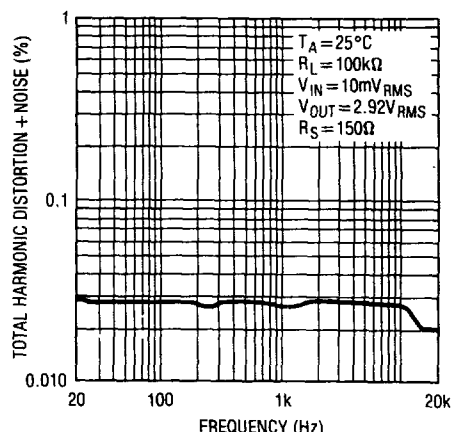



# TYPICAL APPLICATIONS

Figure 2. Low Noise DC Accurate  $\times 10$  Buffered Line Amplifier

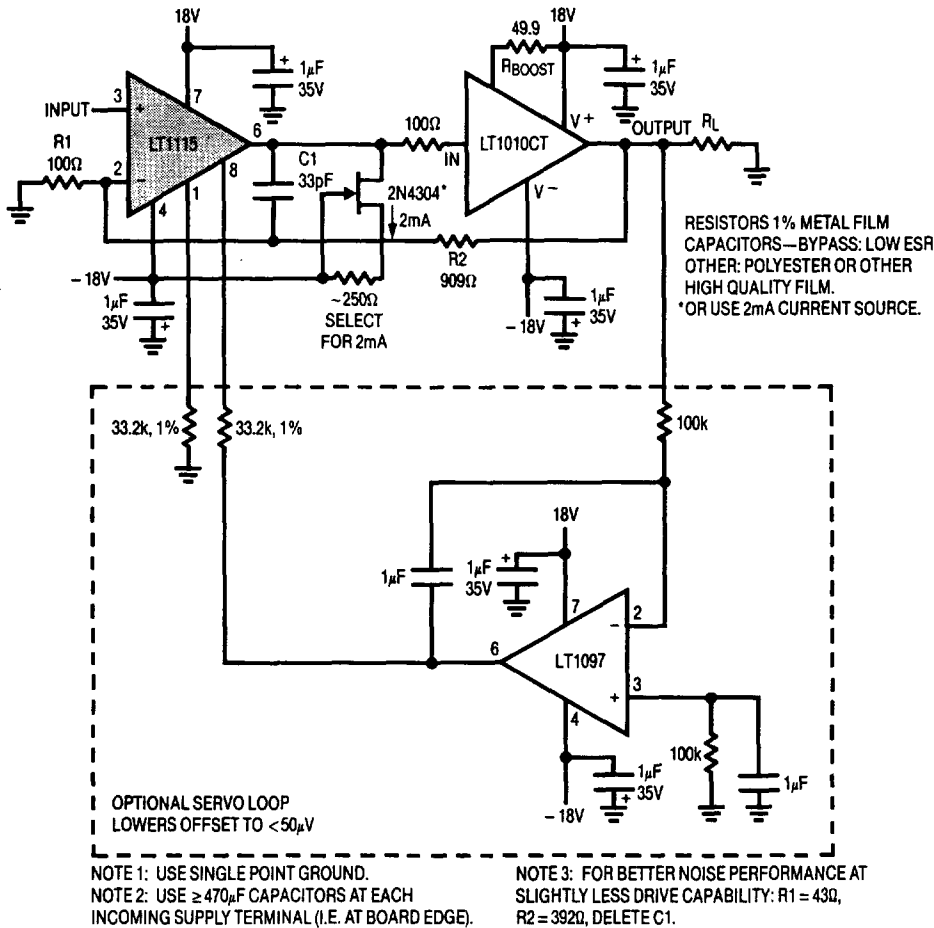

THD + Noise vs Frequency  
(Figure 2)

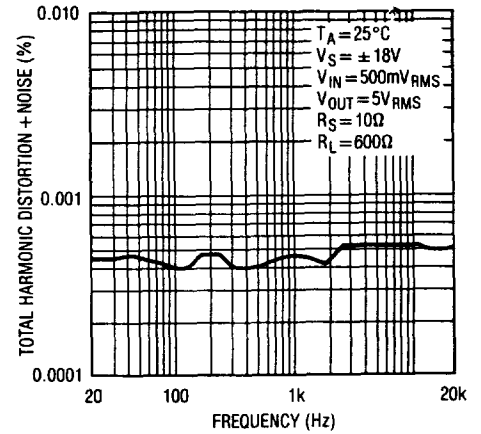

CCIF IMD Test (Twin Tones at 13  
and 14kHz) (Figure 3)

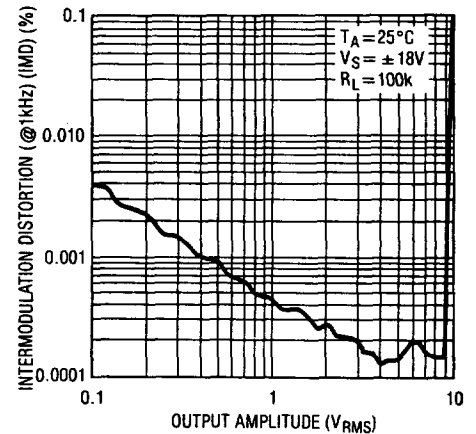
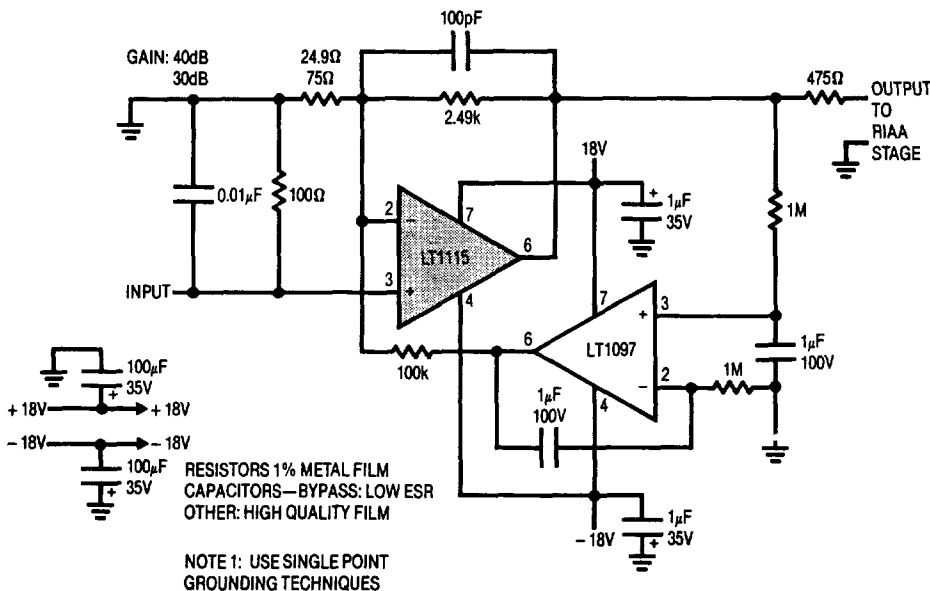
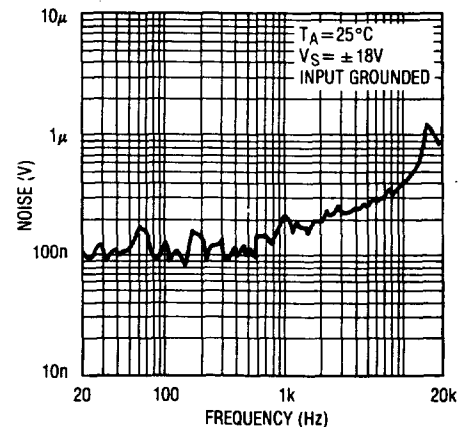

Figure 3. RIAA Moving Coil "Pre-Pre" Amplifier  
(+ 40/ + 30dB Gain Low Noise Servo'd Amplifier)



Noise vs Frequency (Figure 3)



NOTE: NOISE AT 1kHz REFERRED TO INPUT  $\sim 2\text{nV}$

# TYPICAL APPLICATIONS

Figure 4. Moving Coil Passive RIAA Phonograph Pre-Amp

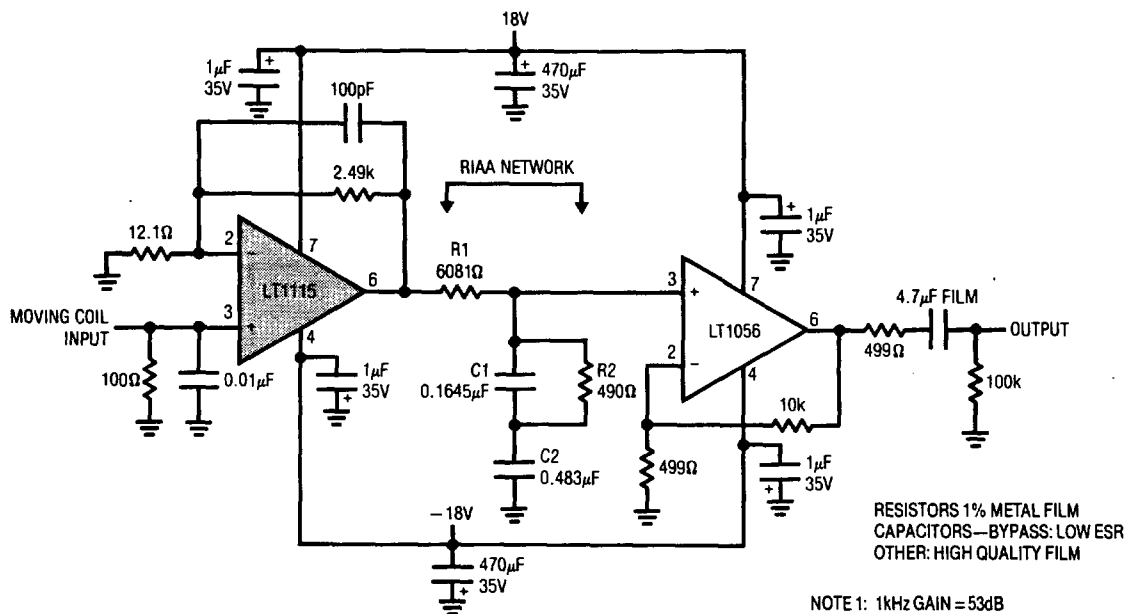

NOTE 1: 1kHz GAIN = 53dB  
NOTE 2: IN RIAA NETWORK VALUES SHOWN ARE MEASURED AND PRODUCE THE "DEVIATION FROM RIAA" GRAPH SHOWN. THE CALCULATED EXACT VALUES ARE:  
R1-6249Ω C1-0.161μF  
R2-504Ω C2-0.47μF

Deviation from RIAA Response  
Input @ 1kHz = 232μV<sub>RMS</sub>  
Pre-Emphasized (Figure 4)

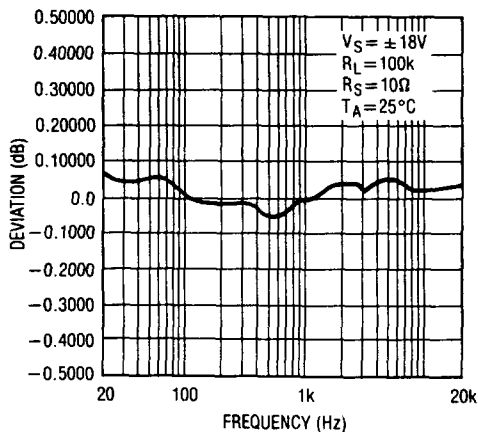

THD + Noise vs Frequency  
Input @ 1kHz = 232μV<sub>RMS</sub>  
Pre-Emphasized (Figure 4)

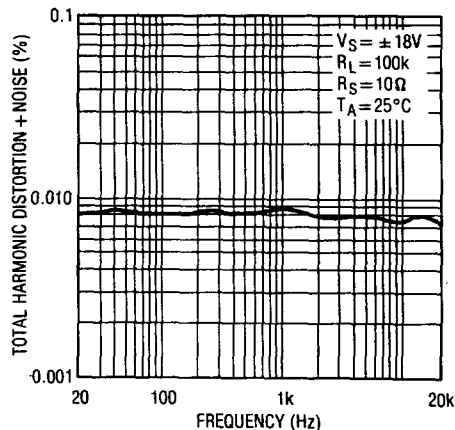

# TYPICAL APPLICATIONS

Figure 5. High Performance Transformer Coupled Microphone Pre-Amp

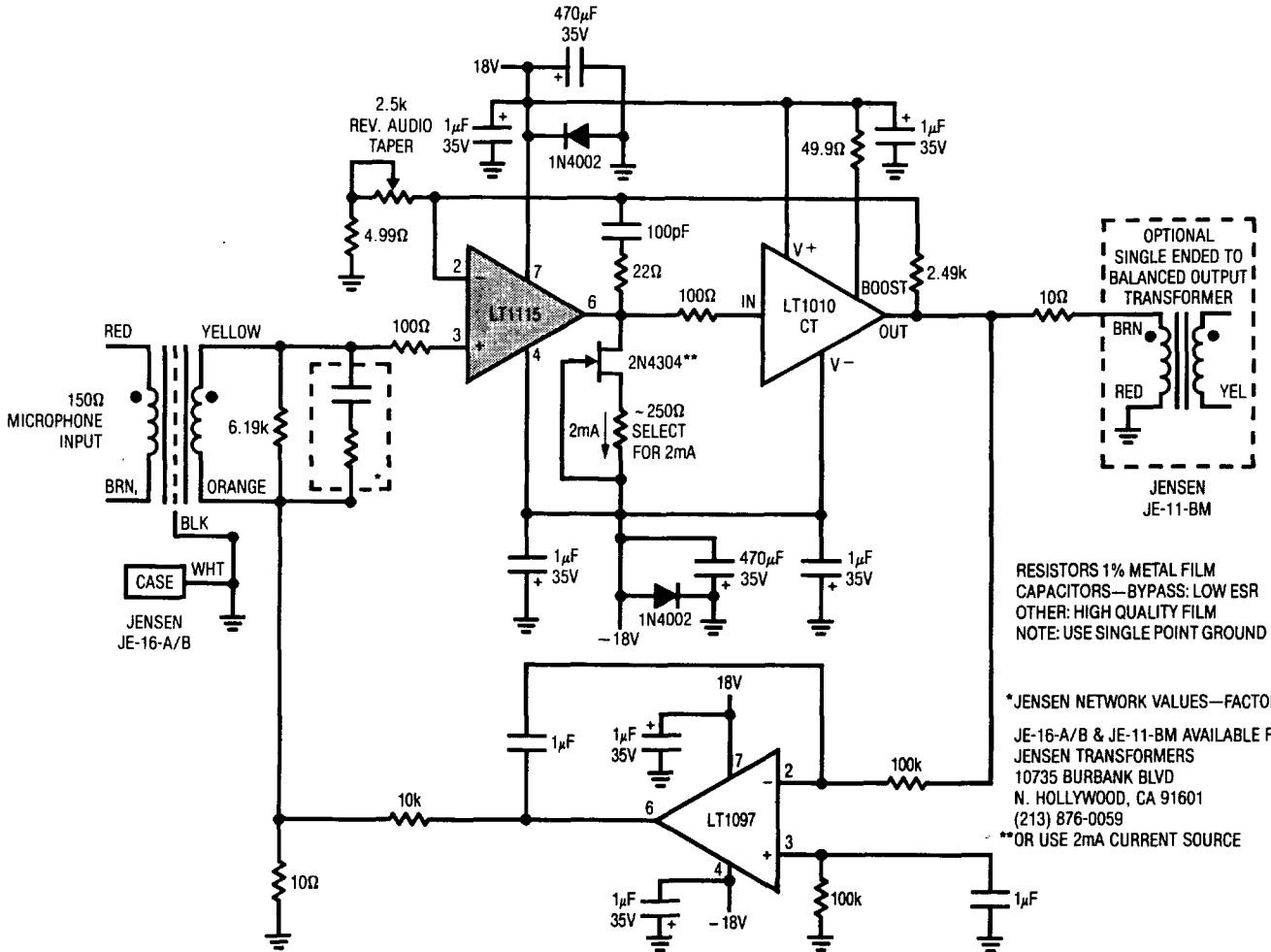

RESISTORS 1% METAL FILM  
CAPACITORS—BYPASS: LOW ESR  
OTHER: HIGH QUALITY FILM  
NOTE: USE SINGLE POINT GROUND

\*JENSEN NETWORK VALUES—FACTORY SELECTED.

JE-16-A/B & JE-11-BM AVAILABLE FROM:  
JENSEN TRANSFORMERS  
10735 BURBANK BLVD  
N. HOLLYWOOD, CA 91601  
(213) 876-0059

\*\*OR USE 2mA CURRENT SOURCE

Risetime of High Performance Transformer Coupled Microphone Pre-Amp (Figure 5)

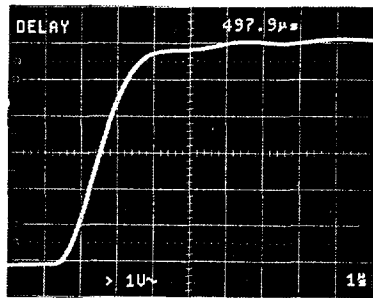

RISETIME OF PRE-AMP  
 $A_V = 20\text{dB}$   
 $V_{IN} = 400\text{mV}$   
2kHz SQUARE WAVE MEASURED AT SINGLE ENDED OUTPUT BEFORE TRANSFORMER

THD + Noise vs Frequency (Gain = 20dB) Balanced In/ Balanced Out (Figure 5)

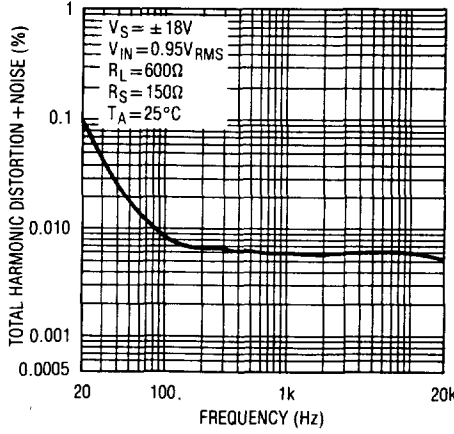

Frequency Response (Gain = 20dB) Balanced In/ Balanced Out (Figure 5)

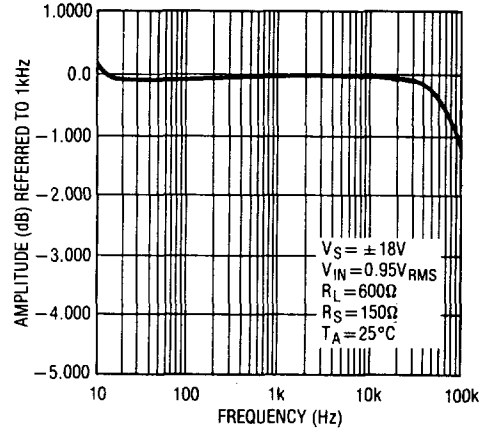

# TYPICAL APPLICATIONS

Figure 6. Ultra Low THD Oscillator (Sine Wave) (<5ppm Distortion)

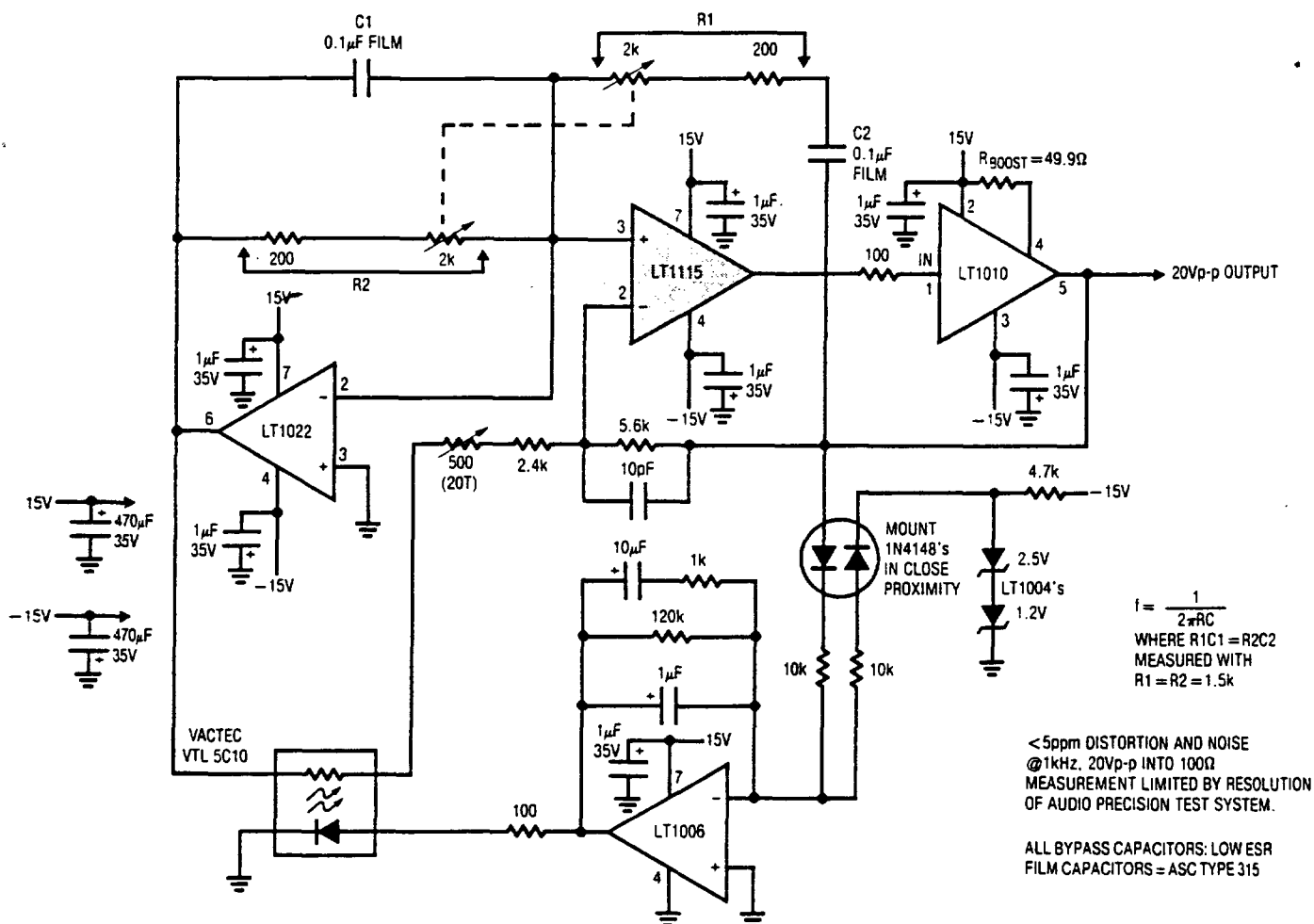

2