

The RF Line

NPN Silicon

RF Power Transistor

Designed for 26 volts microwave large-signal, common emitter, class A and class AB linear amplifier applications in industrial and commercial FM/AM equipment operating in the range 1400–1600 MHz.

- Specified 26 Volts, 1490 MHz, Class AB Characteristics
 - Output Power — 90 Watts (PEP)
 - Gain — 7.5 dB Min @ 90 Watts (PEP)
 - Collector Efficiency — 30% Min @ 90 Watts (PEP)
 - Intermodulation Distortion — -28 dBc Max @ 90 Watts (PEP)
- Third Order Intercept Point — 56.5 dBm Typ @ 1490 MHz, $V_{CE} = 24$ Vdc, $I_C = 5$ Adc
- Characterized with Series Equivalent Large-Signal Parameters from 1400–1600 MHz
- Characterized with Small-Signal S-Parameters from 1000–2000 MHz
- Silicon Nitride Passivated
- 100% Tested for Load Mismatch Stress at All Phase Angles with 3:1 Load VSWR @ 28 Vdc, and Rated Output Power
- Gold Metallized, Emitter Ballasted for Long Life and Resistance to Metal Migration
- Circuit board photomaster available upon request by contacting RF Tactical Marketing in Phoenix, AZ.

MRF15090

90 W, 1.5 GHz
RF POWER TRANSISTOR
NPN SILICON

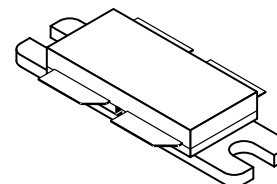

CASE 375A-01, STYLE 1

MAXIMUM RATINGS

Rating	Symbol	Value	Unit
Collector-Emitter Voltage	V_{CEO}	25	Vdc
Collector-Emitter Voltage	V_{CES}	60	Vdc
Emitter-Base Voltage	V_{EBO}	4	Vdc
Collector-Current — Continuous @ $T_J(\text{max}) = 150^\circ\text{C}$	I_C	15	Adc
Total Device Dissipation @ $T_C = 25^\circ\text{C}$ Derate above 25°C	P_D	250 1.43	Watts $\text{W}/^\circ\text{C}$
Storage Temperature Range	T_{stg}	-65 to +150	$^\circ\text{C}$

THERMAL CHARACTERISTICS

Characteristic	Symbol	Max	Unit
Thermal Resistance, Junction to Case	$R_{\theta JC}$	0.70	$^\circ\text{C}/\text{W}$

ELECTRICAL CHARACTERISTICS ($T_C = 25^\circ\text{C}$ unless otherwise noted.)

Characteristic	Symbol	Min	Typ	Max	Unit
----------------	--------	-----	-----	-----	------

OFF CHARACTERISTICS

Collector-Emitter Breakdown Voltage ($I_C = 50$ mAdc, $I_B = 0$)	$V_{(BR)CEO}$	25	28	—	Vdc
Collector-Emitter Breakdown Voltage ($I_C = 50$ mAdc, $V_{BE} = 0$)	$V_{(BR)CES}$	60	65	—	Vdc
Collector-Emitter Breakdown Voltage ($I_C = 50$ mAdc, $R_{BE} = 100 \Omega$)	$V_{(BR)CER}$	30	—	—	Vdc

(continued)

ELECTRICAL CHARACTERISTICS — continued ($T_C = 25^\circ\text{C}$ unless otherwise noted.)

Characteristic	Symbol	Min	Typ	Max	Unit
----------------	--------	-----	-----	-----	------

OFF CHARACTERISTICS — continued

Emitter–Base Breakdown Voltage ($I_E = 5 \text{ mA}$, $I_C = 0$)	$V_{(BR)EBO}$	4	4.8	—	Vdc
Collector Cutoff Current ($V_{CE} = 30 \text{ Vdc}$, $V_{BE} = 0$)	I_{CES}	—	—	10	mA

ON CHARACTERISTICS

DC Current Gain ($I_{CE} = 1 \text{ A}$, $V_{CE} = 5 \text{ Vdc}$)	h_{FE}	20	40	80	—
--	----------	----	----	----	---

DYNAMIC CHARACTERISTICS

Output Capacitance ($V_{CB} = 26 \text{ Vdc}$, $I_E = 0$, $f = 1 \text{ MHz}$) – For Information Only. This Part Is Collector Matched.	C_{ob}	—	52	—	pF
--	----------	---	----	---	----

FUNCTIONAL TESTS (Figure 12)

Common–Emitter Amplifier Power Gain ($V_{CC} = 26 \text{ Vdc}$, $P_{out} = 90 \text{ W (PEP)}$, $I_{CQ} = 250 \text{ mA}$, $f_1 = 1490 \text{ MHz}$, $f_2 = 1490.1 \text{ MHz}$)	G_{pe}	7.5	8.3	—	dB
Collector Efficiency ($V_{CC} = 26 \text{ Vdc}$, $P_{out} = 90 \text{ W (PEP)}$, $I_{CQ} = 250 \text{ mA}$, $f_1 = 1490 \text{ MHz}$, $f_2 = 1490.1 \text{ MHz}$)	η	30	36	—	%
Intermodulation Distortion ($V_{CC} = 26 \text{ Vdc}$, $P_{out} = 90 \text{ W (PEP)}$, $I_{CQ} = 250 \text{ mA}$, $f_1 = 1490 \text{ MHz}$, $f_2 = 1490.1 \text{ MHz}$)	IMD	—	– 32	– 28	dBc
Input Return Loss ($V_{CC} = 26 \text{ Vdc}$, $P_{out} = 90 \text{ W (PEP)}$, $I_{CQ} = 250 \text{ mA}$, $f_1 = 1490 \text{ MHz}$, $f_2 = 1490.1 \text{ MHz}$)	IRL	12	15	—	dB
Load Mismatch ($V_{CC} = 28 \text{ Vdc}$, $P_{out} = 90 \text{ W (PEP)}$, $I_{CQ} = 250 \text{ mA}$, $f_1 = 1490 \text{ MHz}$, $f_2 = 1490.1 \text{ MHz}$, Load VSWR = 3:1, All Phase Angles at Frequency of Test)	ψ	No Degradation in Output Power			

TYPICAL CHARACTERISTICS

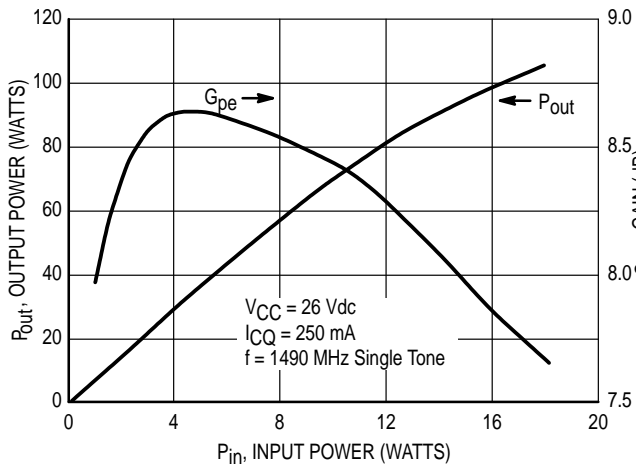

Figure 1. Output Power & Power Gain versus Input Power

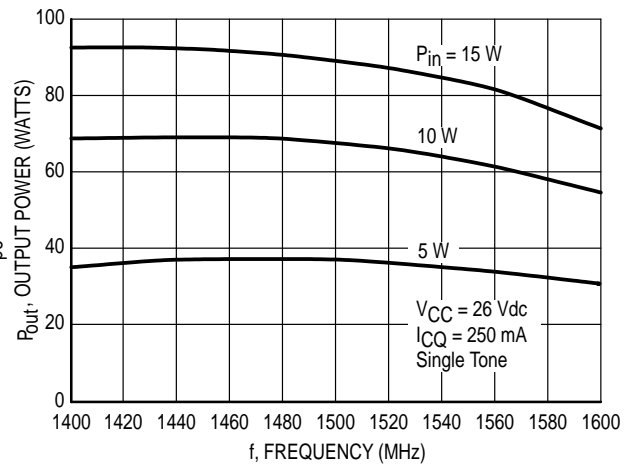

Figure 2. Output Power versus Frequency

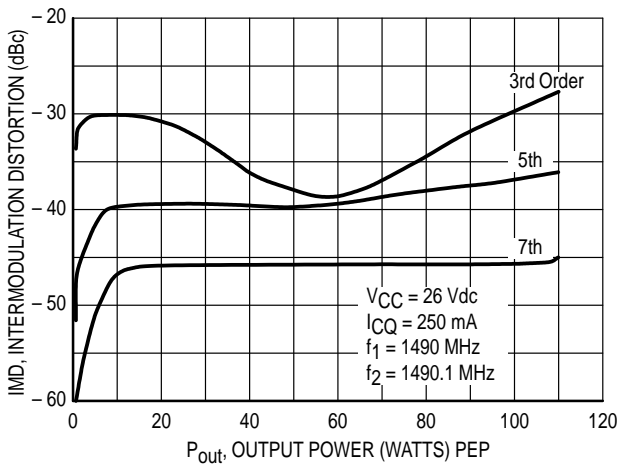

Figure 3. Intermodulation Distortion versus Output Power

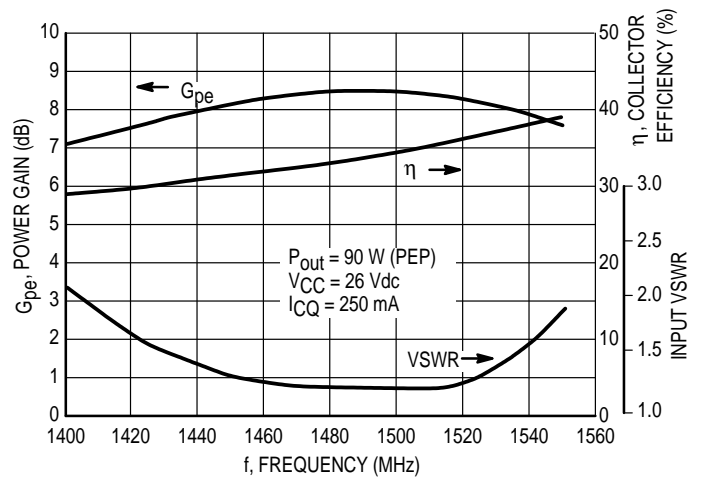

Figure 4. Performance in Broadband Circuit

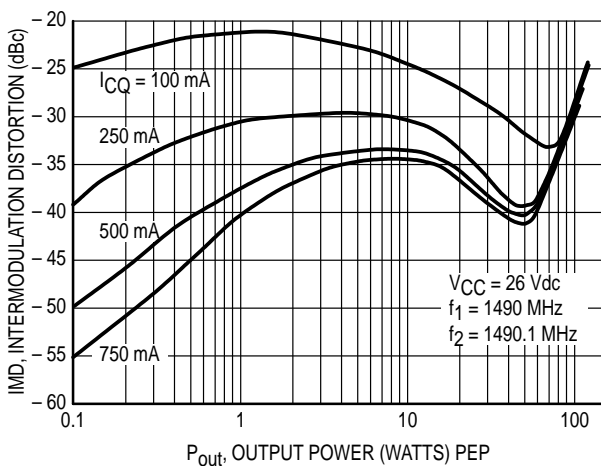

Figure 5. Intermodulation Distortion versus Output Power

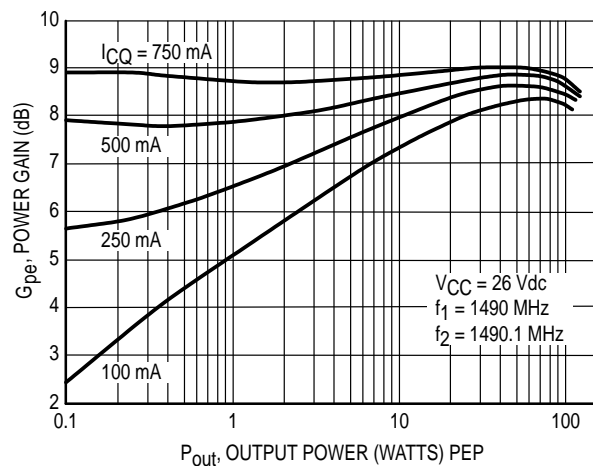

Figure 6. Power Gain versus Output Power

TYPICAL CHARACTERISTICS

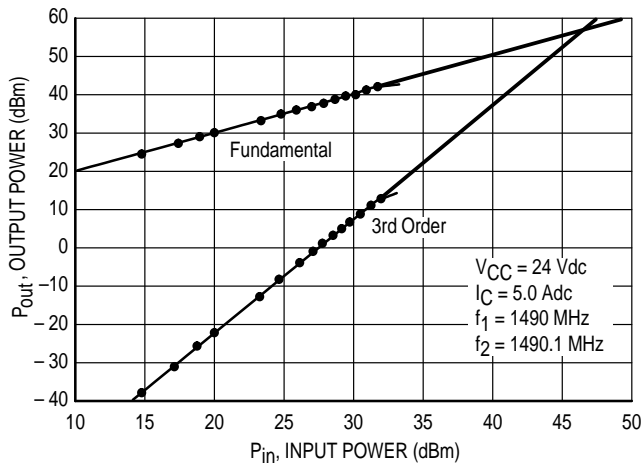

Figure 7. Class A Third Order Intercept Point

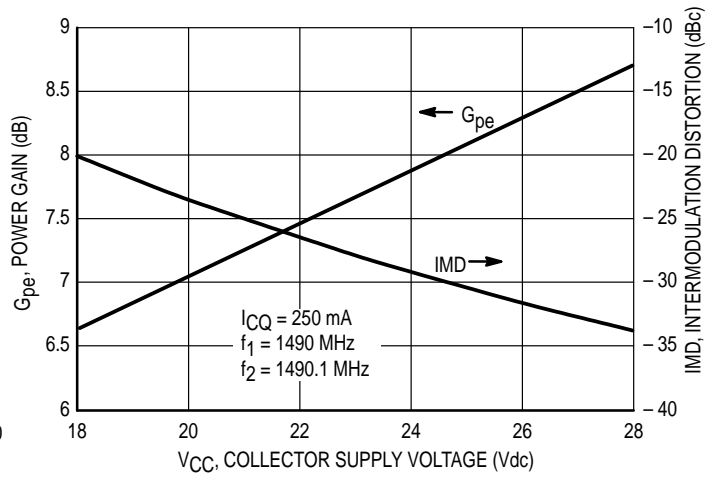

Figure 8. Power Gain and Intermodulation Distortion versus Supply Voltage

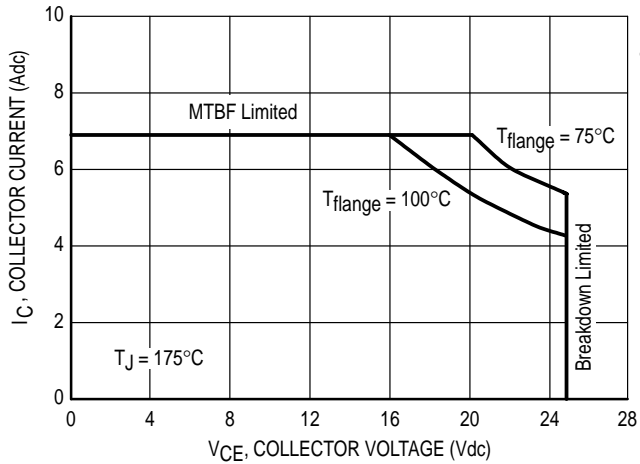

Figure 9. DC Safe Operating Area

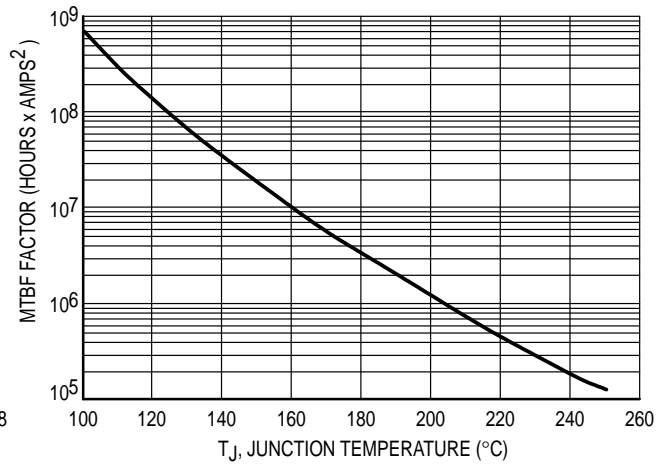
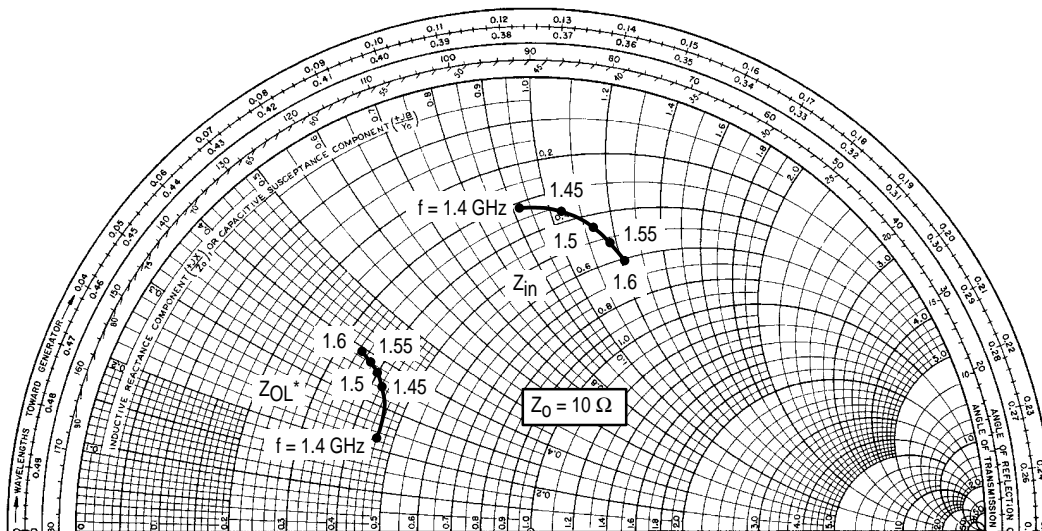

Figure 10. MTBF Factor versus Junction Temperature

The graph above displays calculated MTBF in hours x ampere² emitter current. Life tests at elevated temperatures have correlated to better than $\pm 10\%$ of the theoretical prediction for metal failure. Divide MTBF Factor by I_C^2 for MTBF in a particular application.



f (MHz)	Z _{in} (Ω)	Z _{OL} * (Ω)
1400	3.28 + j9.07	4.62 + j2.23
1450	3.85 + j10.4	4.35 + j3.41
1500	4.55 + j11.4	4.08 + j3.60
1550	5.45 + j11.9	3.80 + j3.78
1600	6.20 + j12.2	3.55 + j3.84

Z_{in} = Input impedance is a balanced base to base measurement.

Z_{OL}* = Conjugate of optimum load impedance collector to collector into which the device operates at a given output power, bias current, voltage and frequency.

Figure 11. Input and Output Impedances with Circuit Tuned for Maximum Gain @ P_{out} = 90 Watts (PEP), V_{CC} = 26 Volts, I_{CQ} = 250 mA, and Driven by Two Equal Amplitude Tones with Separation of 100 KHz

Table 1. Common Emitter S-Parameters (for One Side of Push-Pull MRF15090) at V_{CE} = 24 Vdc, I_C = 2.5 Adc

f MHz	S ₁₁		S ₂₁		S ₁₂		S ₂₂	
	S ₁₁	φ	S ₂₁	φ	S ₁₂	φ	S ₂₂	φ
1000	0.999	172	0.164	108	0.006	72	0.957	173
1050	0.999	171	0.179	103	0.007	69	0.956	172
1100	0.994	170	0.196	97	0.007	66	0.948	172
1150	0.992	170	0.216	92	0.008	63	0.940	171
1200	0.994	169	0.241	86	0.008	62	0.935	171
1250	0.986	168	0.269	80	0.009	57	0.924	170
1300	0.982	167	0.306	73	0.010	51	0.915	170
1350	0.973	166	0.351	66	0.011	45	0.905	170
1400	0.957	164	0.408	56	0.012	33	0.888	170
1450	0.938	163	0.483	44	0.013	22	0.876	170
1500	0.903	162	0.571	29	0.014	7	0.859	171
1550	0.857	163	0.651	10	0.014	-13	0.855	173
1600	0.821	165	0.673	-14	0.013	-40	0.877	174
1650	0.837	169	0.623	-37	0.011	-67	0.902	174
1700	0.872	170	0.529	-56	0.009	-104	0.922	173
1750	0.901	170	0.437	-70	0.008	-138	0.931	172
1800	0.920	170	0.363	-81	0.007	-165	0.932	171
1850	0.940	169	0.309	-90	0.008	173	0.930	170
1900	0.954	169	0.265	-98	0.008	150	0.932	169
1950	0.965	168	0.232	-104	0.009	139	0.930	169
2000	0.971	167	0.205	-110	0.010	132	0.929	168

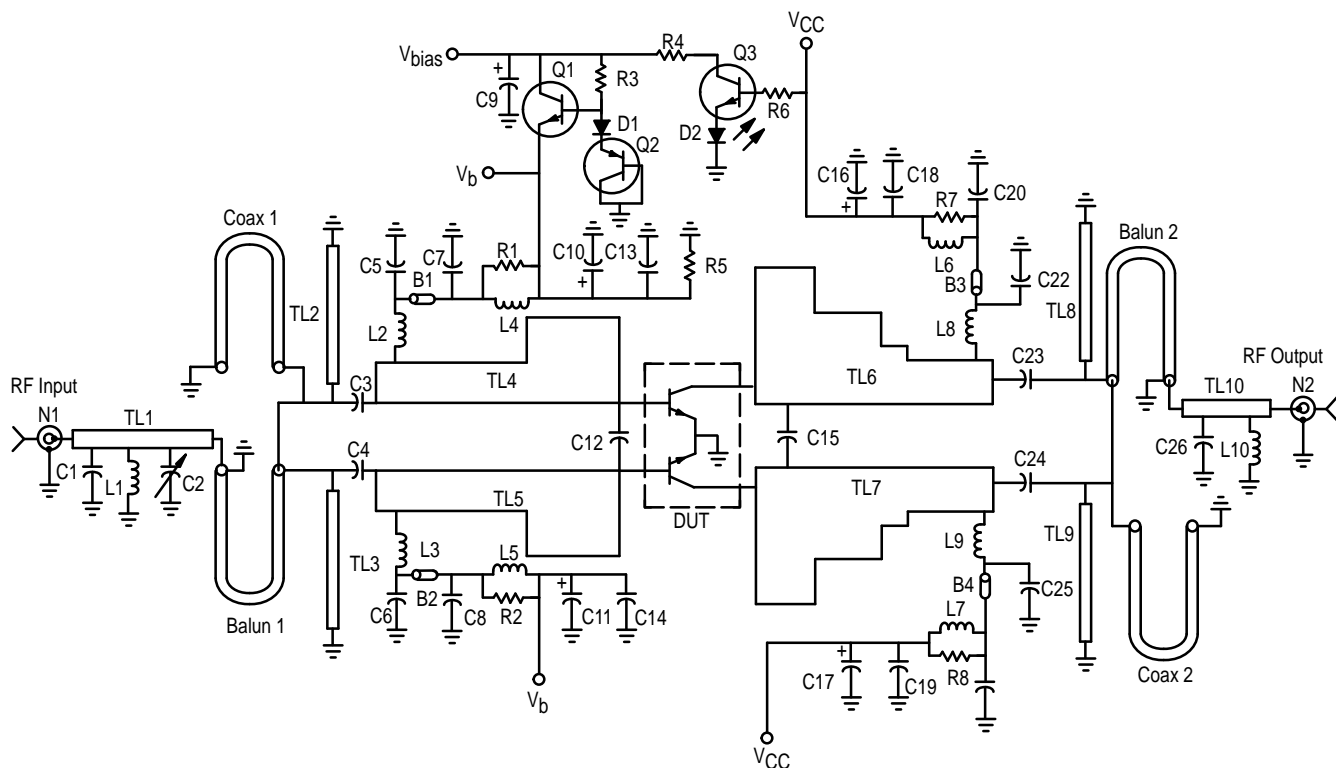

B1, B2, B3, B4	Ferrite Bead, Ferroxcube	L1	1 Turn, 24 AWG, 0.042" ID Choke
C1	2.7 pF, B Case Chip Capacitor, ATC	L2, L3, L8, L9	3 Turn, 20 AWG, 0.126" ID Choke
C2	0.6–4.0 pF, Variable Capacitor, Johanson	L4, L5, L6, L7	12 Turns, 22 AWG, 0.140" ID Choke
C3, C4, C23, C24	18 pF, B Case Chip Capacitor, ATC	L10	3 Turns, 24 AWG, 0.046" ID Choke
C5, C6, C22, C25	51 pF, Chip Capacitor, Murata Erie	N1, N2	Type N Flange Mount RF Connector, Omni Spectra
C7, C8, C20, C21	1800 pF, Chip Capacitor, Kemit	Q1, Q3	Transistor, NPN, Motorola (MJD47)
C9, C10, C11	100 μ F, Electrolytic Capacitor, Mallory	Q2	Transistor PNP Motorola (BD136)
C12	5.1 pF, A Case Chip Capacitor, ATC	R1, R2, R7, R8	10 Ω , 1/2 W, Resistor
C13, C14, C18, C19	0.1 μ F, Chip Capacitor, Kemit	R3	150 Ω , 1/2 W, Resistor
C15	1.1 pF, B Case Chip Capacitor, ATC	R4	2 x 66 Ω , 1/8 W, Chip Resistors in Parallel, Rohm
C16, C17	470 μ F, Electrolytic Capacitor, Mallory	R5	93 Ω , 1/8 W, Chip Resistor, Rohm
C26	0.3 pF, B Case Chip Capacitor, ATC	R6	22 K Ω , 1/8 W, Chip Resistor, Rohm
D1	Diode, Motorola (MUR5120T3)	TL1 to TL10	See Photomaster
D2	Light Emitting Diode, Industrial Devices	Board	Glass Teflon [®] , Arlon GX-0300-55-22, $\epsilon_r = 2.55$

Figure 12. Class AB Test Fixture Electrical Schematic

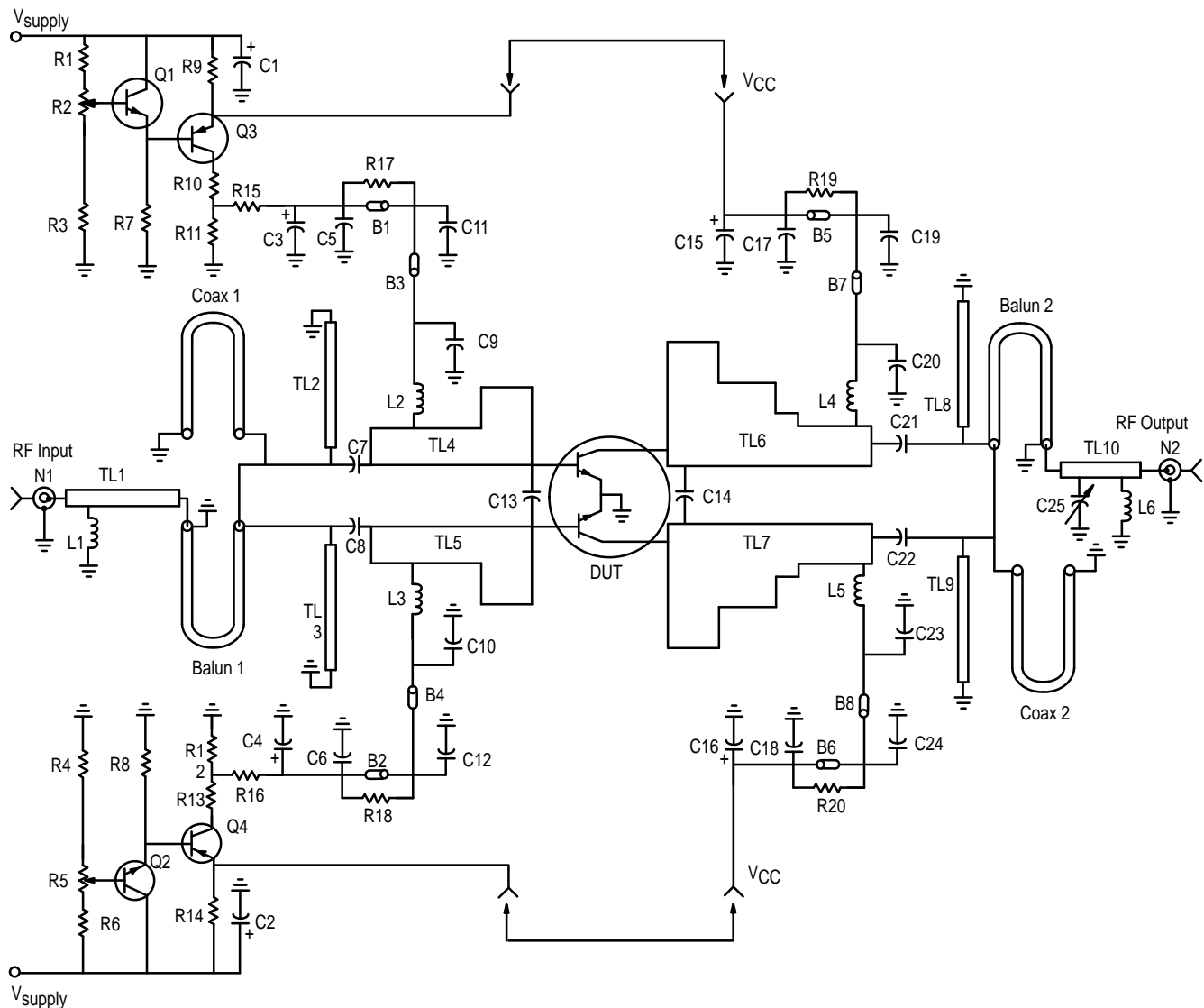

B1, B2, B5, B6	Long Bead, Fair Rite	N1, N2	Type N Flange Mount RF Connector, Omni Spectra
B3, B4, B7, B8	Short Bead, Fair Rite	Q1, Q2	Transistor NPN Motorola (BD135)
C1, C2, C3, C4	100 μ F, Electrolytic Capacitor, Mallory	Q3, Q4	Transistor PNP Motorola (BD136)
C5, C6, C17, C18	0.1 μ F, Chip Capacitor, Kemit	R1, R6	250 Ω , 1/8 W, Chip Resistor, Rohm
C7, C8, C21, C22	18 pF, B Case Chip Capacitor, ATC	R2, R5	500 Ω , 1/4 W, Potentiometer, State of the Art
C9, C10, C20, C23	51 pF, Chip Capacitor, Murata Erie	R3, R4	4.7 Ω , 1/8 W, Chip Resistor, Rohm
C11, C12, C19, C24	1800 pF, Chip Capacitor, Kemit	R7, R8	2 x 4.7 K Ω , 1/8 W, Chip Resistors in Parallel, Rohm
C13	4.3 pF, B Case Chip Capacitor, ATC	R9, R14	1.0 Ω , 10 W, Resistor, Dale
C14	2.0 pF, B Case Chip Capacitor, ATC	R10, R13	38 Ω , 1 W, Resistor
C15, C16	470 μ F, Electrolytic Capacitor, Mallory	R11, R12	75 Ω , 1/8 W, Chip Resistor, Rohm
C25	0.6–4 pF Variable Capacitor, Johanson	R15, R16	2 x 10 Ω , 1/8 W, Chip Resistors in Parallel, Rohm
L1	3 Turns, 24 AWG, 0.046" ID Choke	R17, R18, R19, R20	4 x 38 Ω , 1/8 W, Chip Resistors in Parallel, Rohm
L2, L3, L4, L5	3 Turns, 20 AWG, 0.126" ID Choke		Glass Teflon [®] , Arlon GX-0300-55-22, $\epsilon_r = 2.55$
L6	2 Turns, 24 AWG, 0.042" ID Choke		

Figure 13. Class A Test Fixture Electrical Schematic

PACKAGE DIMENSIONS

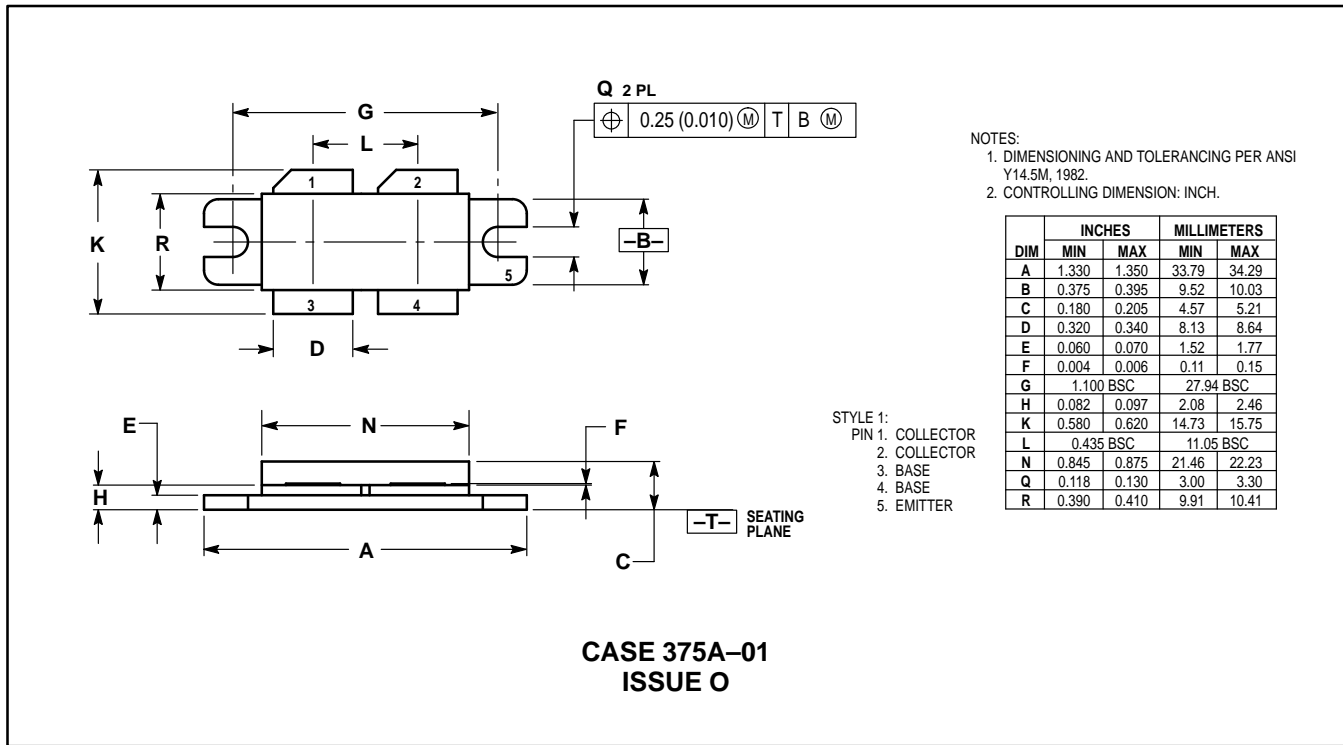

Motorola reserves the right to make changes without further notice to any products herein. Motorola makes no warranty, representation or guarantee regarding the suitability of its products for any particular purpose, nor does Motorola assume any liability arising out of the application or use of any product or circuit, and specifically disclaims any and all liability, including without limitation consequential or incidental damages. "Typical" parameters which may be provided in Motorola data sheets and/or specifications can and do vary in different applications and actual performance may vary over time. All operating parameters, including "Typicals" must be validated for each customer application by customer's technical experts. Motorola does not convey any license under its patent rights nor the rights of others. Motorola products are not designed, intended, or authorized for use as components in systems intended for surgical implant into the body, or other applications intended to support or sustain life, or for any other application in which the failure of the Motorola product could create a situation where personal injury or death may occur. Should Buyer purchase or use Motorola products for any such unintended or unauthorized application, Buyer shall indemnify and hold Motorola and its officers, employees, subsidiaries, affiliates, and distributors harmless against all claims, costs, damages, and expenses, and reasonable attorney fees arising out of, directly or indirectly, any claim of personal injury or death associated with such unintended or unauthorized use, even if such claim alleges that Motorola was negligent regarding the design or manufacture of the part. Motorola and are registered trademarks of Motorola, Inc. Motorola, Inc. is an Equal Opportunity/Affirmative Action Employer.

Mfax is a trademark of Motorola, Inc.

How to reach us:

USA/EUROPE/Locations Not Listed: Motorola Literature Distribution;
 P.O. Box 5405, Denver, Colorado 80217. 1-303-675-2140 or 1-800-441-2447

JAPAN: Motorola Japan Ltd.; SPD, Strategic Planning Office, 141,
 4-32-1 Nishi-Gotanda, Shinagawa-ku, Tokyo, Japan. 81-3-5487-8488

Customer Focus Center: 1-800-521-6274

Mfax™: RMFAX0@email.sps.mot.com – TOUCHTONE 1-602-244-6609
 Motorola Fax Back System – US & Canada ONLY 1-800-774-1848
 – http://sps.motorola.com/mfax/

ASIA/PACIFIC: Motorola Semiconductors H.K. Ltd.; 8B Tai Ping Industrial Park,
 51 Ting Kok Road, Tai Po, N.T., Hong Kong. 852-26629298

HOME PAGE: http://motorola.com/sps/

