

Video amplifier

NE5592

DESCRIPTION

The NE5592 is a dual monolithic, two-stage, differential output, wideband video amplifier. It offers a fixed gain of 400 without external components and an adjustable gain from 400 to 0 with one external resistor. The input stage has been designed so that with the addition of a few external reactive elements between the gain select terminals, the circuit can function as a high-pass, low-pass, or band-pass filter. This feature makes the circuit ideal for use as a video or pulse amplifier in communications, magnetic memories, display, video recorder systems, and floppy disk head amplifiers.

FEATURES

- 110MHz unity gain bandwidth
- Adjustable gain from 0 to 400
- Adjustable pass band
- No frequency compensation required
- Wave shaping with minimal external components

PIN CONFIGURATION

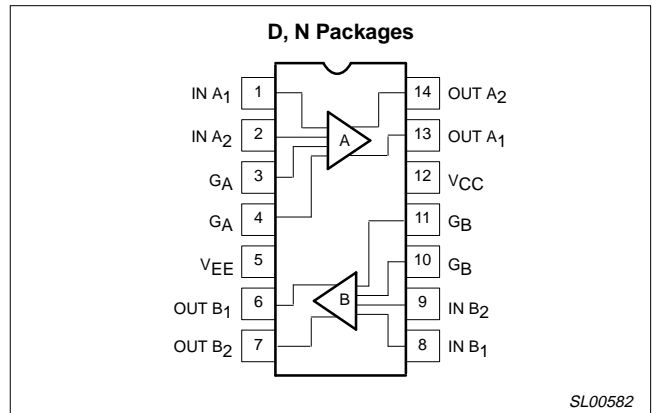

Figure 1. Pin Configuration

APPLICATIONS

- Floppy disk head amplifier
- Video amplifier
- Pulse amplifier in communications
- Magnetic memory
- Video recorder systems

ORDERING INFORMATION

DESCRIPTION	TEMPERATURE RANGE	ORDER CODE	DWG #
14-Pin Plastic Dual In-Line Package (DIP)	0 to 70°C	NE5592N	SOT27-1
14-Pin Small Outline (SO) package	0 to 70°C	NE5592D	SOT108-1

EQUIVALENT CIRCUIT

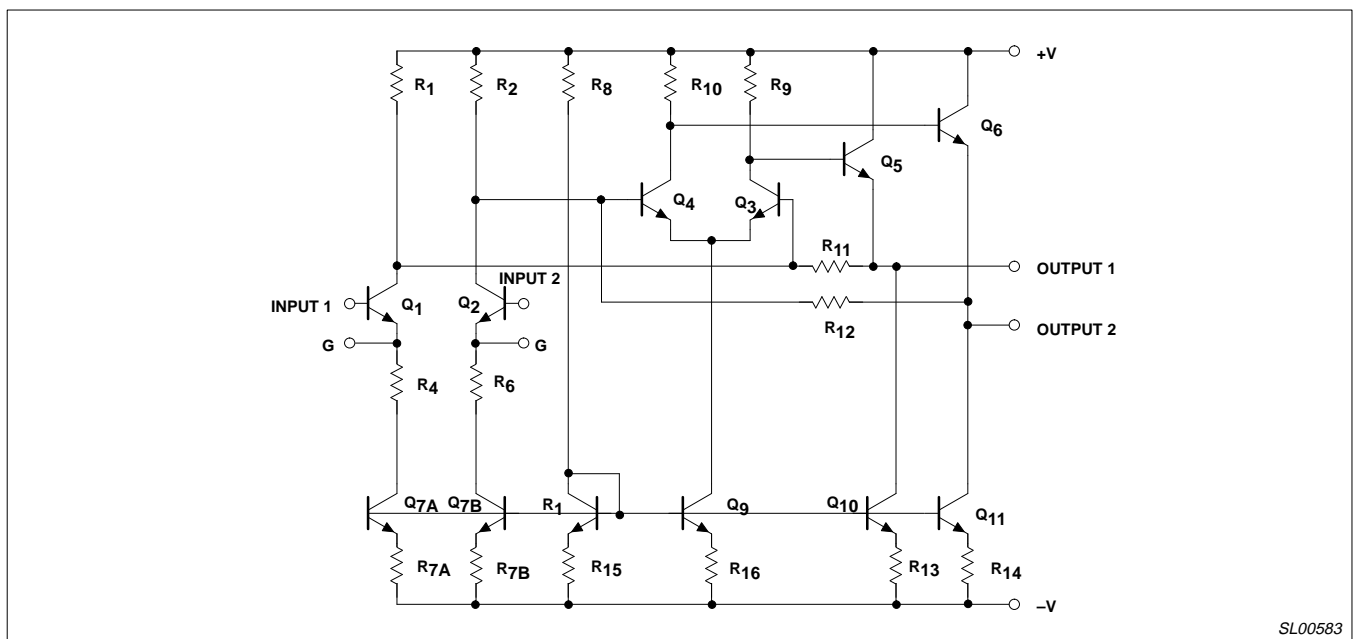

Figure 2. Equivalent Circuit

Video amplifier

NE5592

ABSOLUTE MAXIMUM RATINGS

$T_A=25^\circ\text{C}$, unless otherwise specified.

SYMBOL	PARAMETER	RATING	UNIT
V_{CC}	Supply voltage	± 8	V
V_{IN}	Differential input voltage	± 5	V
V_{CM}	Common mode Input voltage	± 6	V
I_{OUT}	Output current	10	mA
T_A	Operating temperature range NE5592	0 to +70	$^\circ\text{C}$
T_{STG}	Storage temperature range	-65 to +150	$^\circ\text{C}$
$P_{D\text{ MAX}}$	Maximum power dissipation, $T_A=25^\circ\text{C}$ (still air) ¹ D package N package	1.03 1.48	W W

NOTES:

- Derate above 25°C at the following rates:
D package $8.3\text{mW}/^\circ\text{C}$
N package $11.9\text{mW}/^\circ\text{C}$

DC ELECTRICAL CHARACTERISTICS

$T_A=+25^\circ\text{C}$, $V_{SS}=\pm 6\text{V}$, $V_{CM}=0$, unless otherwise specified. Recommended operating supply voltage is $V_S = \pm 6.0\text{V}$, and gain select pins are connected together.

SYMBOL	PARAMETER	TEST CONDITIONS	LIMITS			UNITS
			Min	Typ	Max	
A_{VOL}	Differential voltage gain	$R_L=2\text{k}\Omega$, $V_{OUT}=3V_{P-P}$	400	480	600	V/V
R_{IN}	Input resistance		3	14		$\text{k}\Omega$
C_{IN}	Input capacitance			2.5		pF
I_{OS}	Input offset current			0.3	3	μA
I_{BIAS}	Input bias current			5	20	μA
	Input noise voltage	BW 1kHz to 10MHz		4		$\text{nV}/\sqrt{\text{Hz}}$
V_{IN}	Input voltage range		± 1.0			V
$CMRR$	Common-mode rejection ratio	$V_{CM} \pm 1\text{V}$, $f < 100\text{kHz}$ $V_{CM} \pm 1\text{V}$, $f = 5\text{MHz}$	60	93 87		dB dB
$PSRR$	Supply voltage rejection ratio	$\Delta V_S = \pm 0.5\text{V}$	50	85		dB
	Channel separation	$V_{OUT}=1V_{P-P}$; $f=100\text{kHz}$ (output referenced) $R_L=1\text{k}\Omega$	65	70		dB
V_{OS}	Output offset voltage gain select pins open	$R_L=\infty$ $R_L=\infty$		0.5 0.25	1.5 0.75	V V
V_{CM}	Output common-mode voltage	$R_L=\infty$	2.4	3.1	3.4	V
V_{OUT}	Output differential voltage swing	$R_L=2\text{k}\Omega$	3.0	4.0		V
R_{OUT}	Output resistance			20		Ω
I_{CC}	Power supply current (total for both sides)	$R_L=\infty$		35	44	mA

Video amplifier

NE5592

DC ELECTRICAL CHARACTERISTICS

$V_{SS}=\pm 6V$, $V_{CM}=0$, $0^{\circ}C \leq T_A \leq 70^{\circ}C$, unless otherwise specified. Recommended operating supply voltage is $V_S = \pm 6.0V$, and gain select pins are connected together.

SYMBOL	PARAMETER	TEST CONDITIONS	LIMITS			UNITS
			Min	Typ	Max	
A_{VOL}	Differential voltage gain	$R_L=2k\Omega$, $V_{OUT}=3V_{P-P}$	350	430	600	V/V
R_{IN}	Input resistance		1	11		k Ω
I_{OS}	Input offset current				5	μA
I_{BIAS}	Input bias current				30	μA
V_{IN}	Input voltage range		± 1.0			V
CMRR	Common-mode rejection ratio	$V_{CM} \pm 1V$, $f < 100kHz$ $R_S = \phi$	55			dB
PSRR	Supply voltage rejection ratio	$\Delta V_S = \pm 0.5V$	50			dB
	Channel separation	$V_{OUT}=1V_{P-P}$; $f=100kHz$ (output referenced) $R_L=1k\Omega$		70		dB
V_{OS}	Output offset voltage					
	gain select pins connected together	$R_L = \infty$			1.5	V
	gain select pins open	$R_L = \infty$			1.0	V
V_{OUT}	Output differential voltage swing	$R_L=2k\Omega$	2.8			V
I_{CC}	Power supply current (total for both sides)	$R_L = \infty$			47	mA

AC ELECTRICAL CHARACTERISTICS

$T_A=+25^{\circ}C$, $V_{SS}=\pm 6V$, $V_{CM}=0$, unless otherwise specified. Recommended operating supply voltage $V_S = \pm 6.0V$. Gain select pins connected together.

SYMBOL	PARAMETER	TEST CONDITIONS	LIMITS			UNITS
			Min	Typ	Max	
BW	Bandwidth	$V_{OUT}=1V_{P-P}$		25		MHz
t_R	Rise time			15	20	ns
t_{PD}	Propagation delay	$V_{OUT}=1V_{P-P}$		7.5	12	ns

TEST CIRCUITS $T_A=25^{\circ}C$ unless otherwise specified.

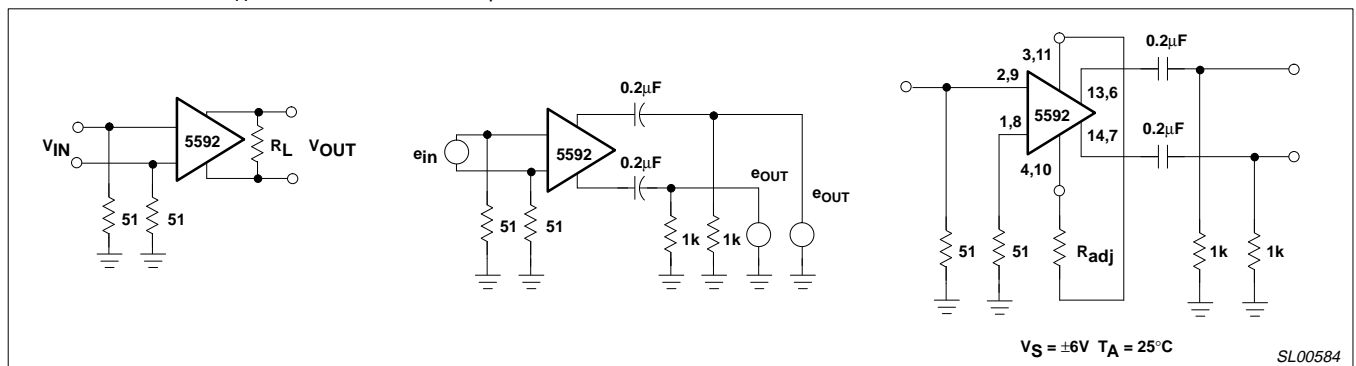

Figure 3. Test Circuits

Video amplifier

NE5592

TYPICAL PERFORMANCE CHARACTERISTICS

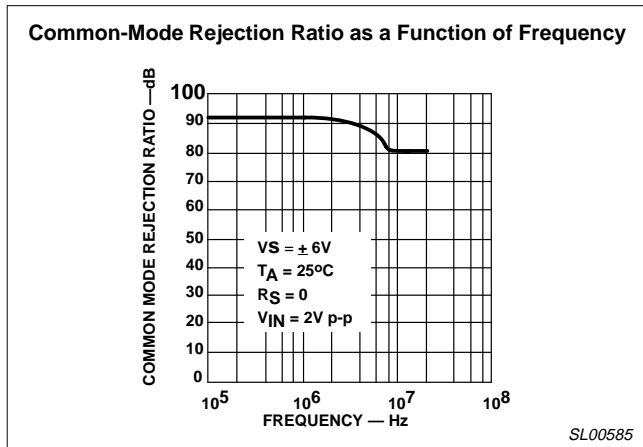

Figure 4.

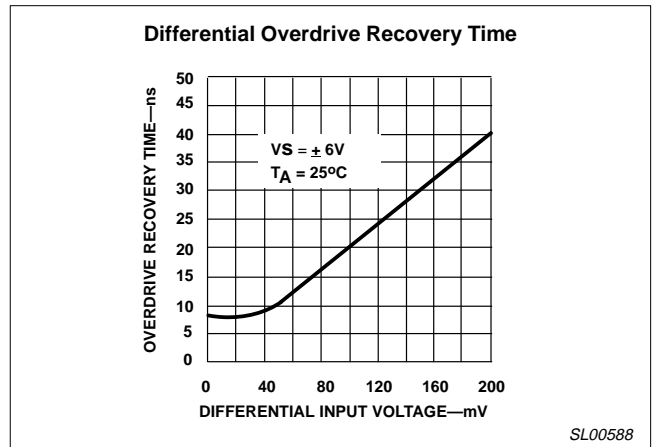

Figure 7.

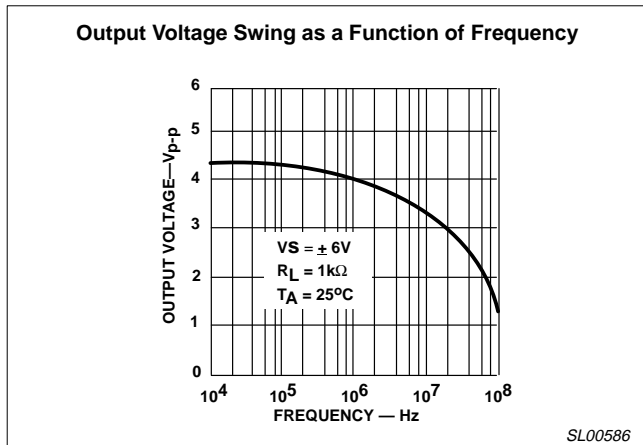

Figure 5.

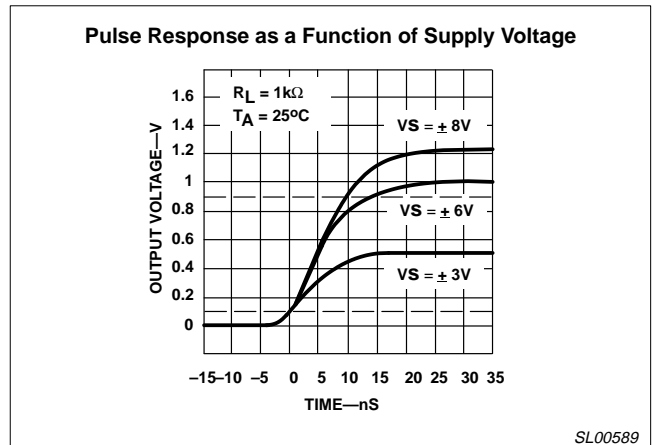

Figure 8.

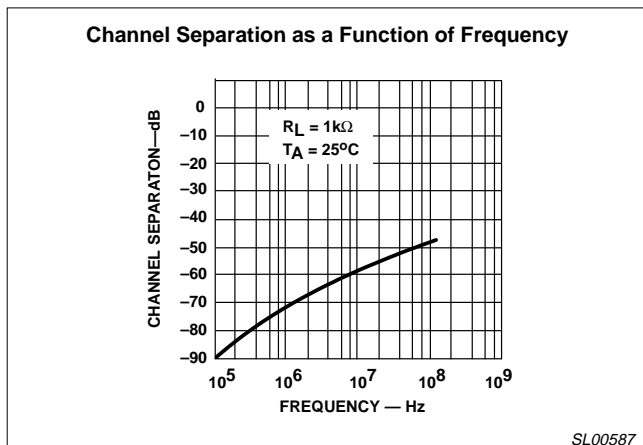

Figure 6.

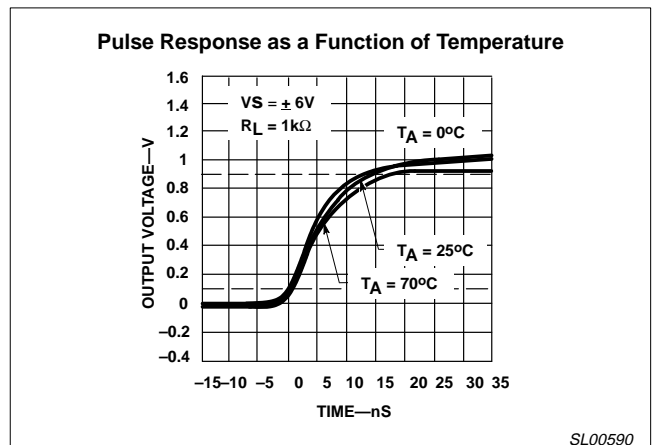

Figure 9.

Video amplifier

NE5592

TYPICAL PERFORMANCE CHARACTERISTICS (Continued)

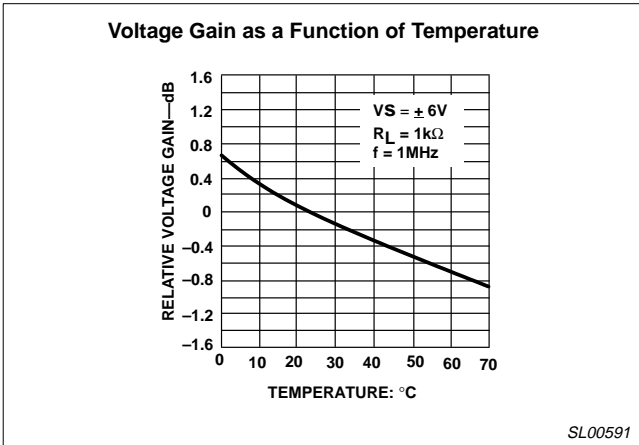

Figure 10.

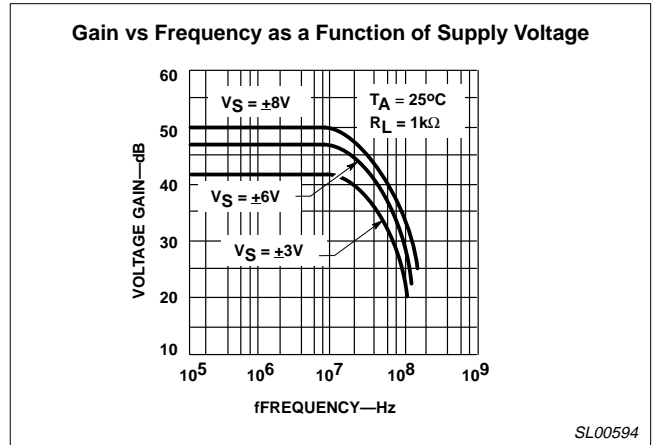

Figure 13.

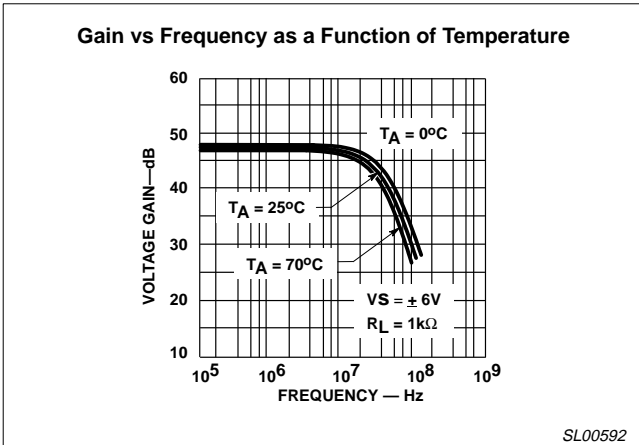

Figure 11.

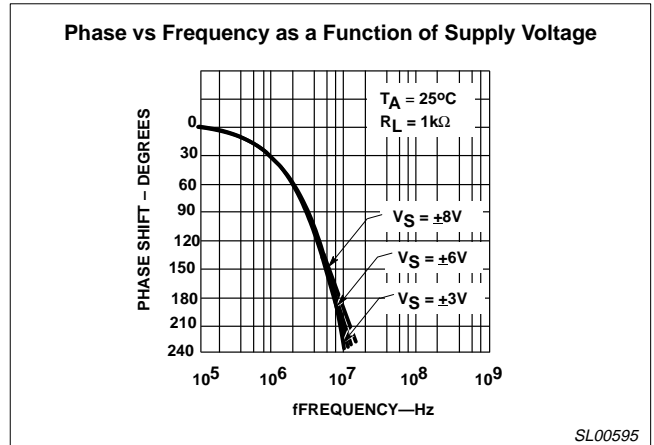

Figure 14.

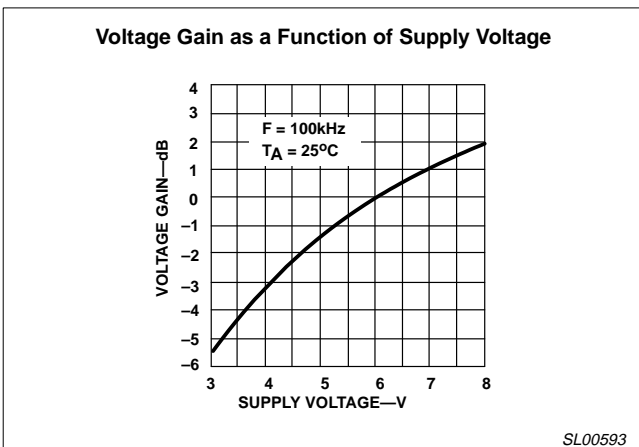

Figure 12.

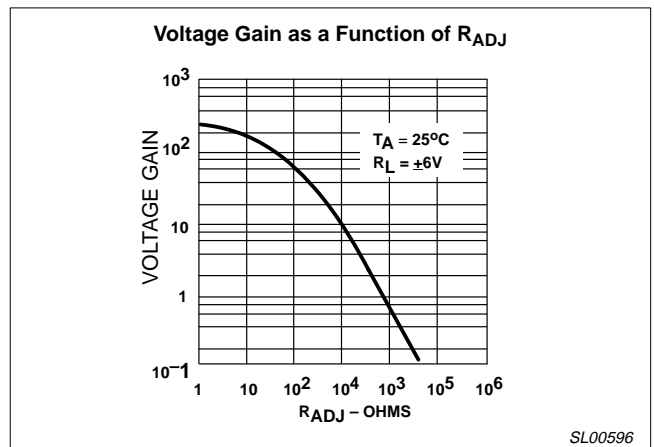

Figure 15.

Video amplifier

NE5592

TYPICAL PERFORMANCE CHARACTERISTICS (Continued)

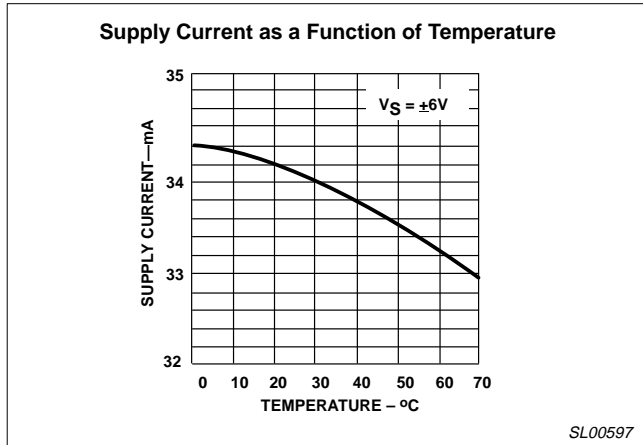

Figure 16.

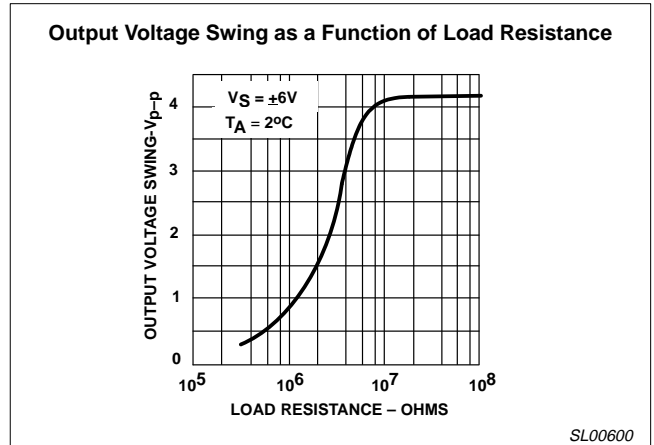

Figure 19.

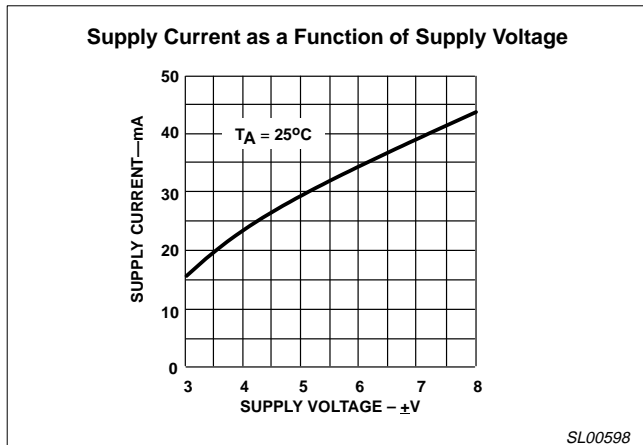

Figure 17.

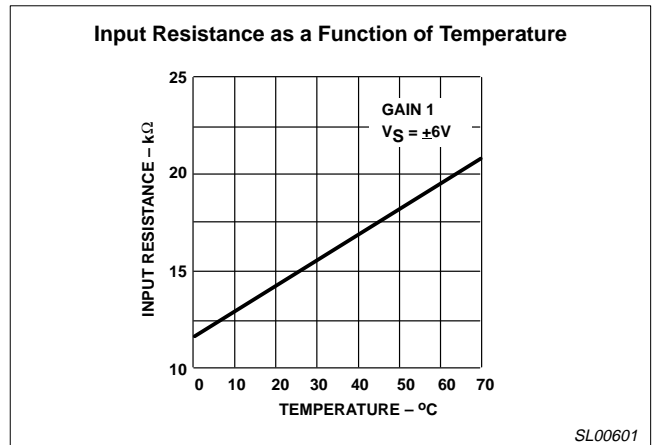

Figure 20.

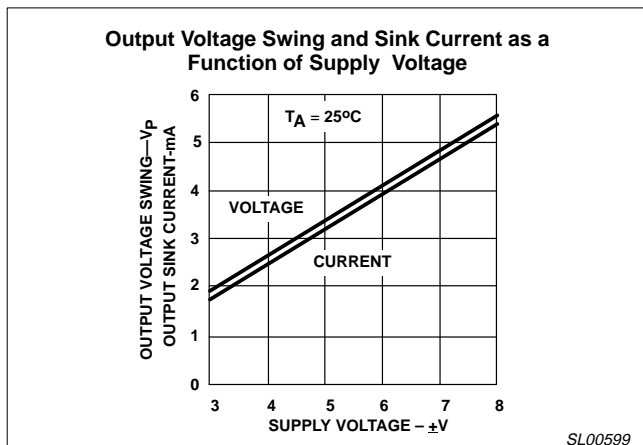

Figure 18.

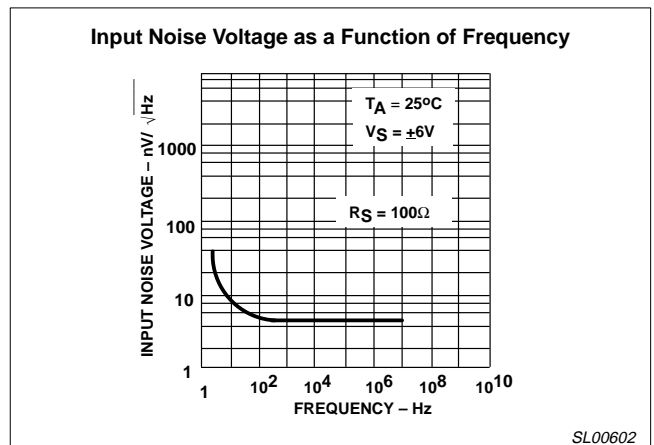

Figure 21.